



HINCHLIFFE MODELS

MELTHAM, HUDDERSFIELD, HD7 3NX, ENGLAND.

NEW RELEASES — JULY 1972 25 mm RANGE

FRENCH NAPOLEONIC CAVALRY (FNC)

- FNC 23 Grenadier à Cheval of the Guard, Trooper
FNC 24 Grenadier à Cheval of the Guard, Officer
FNC 25 Grenadier à Cheval of the Guard, Trumpeter
FNC 26 Chasseur à Cheval of the Guard, Trooper holding carbine at rest
FNC 27 Chasseur à Cheval of the Guard, Officer
FNC 28 Chasseur à Cheval of the Guard, Trumpeter

FRENCH NAPOLEONIC (FN)

- FN 61 Foot Artillery of the Guard, with rammer
FN 62 Foot Artillery of the Guard, with portfire
FN 63 Foot Artillery of the Guard, carrying a bucket
FN 64 Foot Artillery of the Guard, holding drag rope
FN 65 Foot Artillery of the Guard, Officer

DUTCH, BELGIAN NAPOLEONIC CAVALRY (DBNC)

- DBNC 1 Carabinier, Trooper
DBNC 2 Carabinier, Officer
DBNC 3 Carabinier, Trumpeter

RUSSIAN NAPOLEONIC (RN)

- RN 6 Line Grenadier, advancing
RN 7 Line Grenadier, Officer
RN 8 Line Grenadier, Drummer

RUSSIAN NAPOLEONIC CAVALRY (RNC)

- RNC 3 Dragoon Trooper
RNC 4 Dragoon Officer
RNC 5 Dragoon Trumpeter

BRITISH NAPOLEONIC CAVALRY (BNC)

- BNC15 Light Dragoon Trooper
BNC16 Light Dragoon Officer
BNC17 Light Dragoon Trumpeter

PRUSSIAN NAPOLEONIC (PN)

- PN18 Gunner, quenching sponge
PN19 Gunner, carrying round
PN20 Gunner, pulling on wheel spokes
PN21 Gunner, with portfire and linstock
PN22 Gunner, officer

AUSTRIAN NAPOLEONIC CAVALRY (ANC)

- ANC 1 Cuirassier Trooper
ANC 2 Cuirassier Officer
ANC 3 Cuirassier Trumpeter

PERSONALITY FIGURES (PF)

- PF 7 Field Marshal Prince Blucher
PF 8 General Count von Gneisenau
PF 12 General Kutsov
PF 13 Duke of Brunswick
PF 14 Marshal Berthier, Chief of Staff

LIGHT HORSES (LH)

- LH 6 Light Horse, head down, grazing
LH 7 Light Horse, shaggy coat, galloping

EQUIPMENT HORSES (EH)

- EH5A British Nap. Limber Horse, unriden, standing, head thrown up
EH5B British Nap. Limber Horse, ridden, standing, head down

25 mm EQUIPMENT RANGE (25)

- 25/AA British Napoleonic 18PDR Naval gun
25/AB British Napoleonic 18PDR gun on wooden garrison carriage

20 mm RANGE

- 20/23 German W.W.II 150 mm. Nebelwerfer 75p
20/26 German W.W.II 8.8 cm. PAK 43/31 L/71 75p

Foot Figures Cavalry Equipment



30 mm RANGE

Offered now in KIT form they are the ideal size not only for the collector or wargamer but also for he or she who likes to have the odd collectors' piece about home or office. They offer superb detail and authenticity for a modest outlay.

- 30/ 1 British 9-pdr. gun Napoleonic/ Crimea 75p
30/ 2 British Limber Napoleonic/ Crimea 75p
30/ 3 British 3-pdr. Galloper gun 1700-1790 75p
30/ 4 British 24-pdr. gun 1700-1790 75p
30/ 5 British 8 in. Howitzer 1700-1790 75p
30/ 6 British Limber 1700-1790 40p
30/ 7 British Pontoon Wagon 1700-1790 80p
30/ 8 French Napoleonic 8-pdr. gun 80p
30/ 9 French Napoleonic 12-pdr. gun 80p
30/11 British 6-pdr. gun Napoleonic 75p
30/12 British Spare Wheel Carriage Napoleonic/Crimea 75p

Our next releases will include 25 mm. ANCIENTS, more 25 mm. Napoleonics, more 20 mm. W.W.II and the odd piece of 25 mm. equipment. We still measure our figures from the soles of their feet to the top of their heads, we still believe all men were of slightly differing height and we are pleased to say that more and more valued customers are agreeing with us. To you all, we say thank you and may you continue to support your retailer wherever possible.

Our new complete lists are available now — 5p — from your local stockist, or in case of difficulty send S.A.E. and 5p. TRADE ENQUIRIES WELCOMED.



HINCHLIFFE MODELS

MELTHAM, HUDDERSFIELD, HD7 3NX, ENGLAND.

NEW RELEASES — SEPTEMBER 1972

25 mm RANGE

- ROMAN (AR)
- AR 4 Centurion
- AR 3 Light Infantry Slinger
- AR 5 Senior Officer
- AR 8 Asiatic Archer

- ROMAN CAVALRY (ARC)
- ARC 3 German Guard Cavalry

- SASSANID PERSIANS (AS)
- AS 1 Levy Spearman
- AS 2 Mercenary Light Infantry with bow

- SASSANID PERSIAN CAVALRY (ASC)
- ASC 3 Light Cavalry

- BRITISH COLONIAL (BC)
- BC 10 Indian Regular Army, Private advancing
- BC 11 Fuzzi Wuzzi with spear and shield
- BC 12 Zulu crouched behind shield

- BRITISH COLONIAL CAVALRY (BCC)
- BCC 5 British Hussar, Trooper
- BCC 6 British Hussar, Officer
- BCC 7 British Hussar, Trumpeter

BRUNSWICK NAPOLEONIC CAVALRY (BRNC)

- BRNC 1 Hussar, Trooper
- BRNC 2 Hussar, Officer
- BRNC 3 Hussar, Trumpeter

- 25 mm. EQUIPMENT RANGE (25)
- 25/S British Napoleonic Baggage wagon

- 25/Y American Civil War Limber
- 25/Z American Civil War Pontoon wagon

- 25/AC One Cubit Ballista (Roman bolt-throwing engine)

- 20 mm. EQUIPMENT RANGE (20)
- 20/27 British W.W.II 17-pdr. Anti-tank gun

- 20 mm. FIGURE RANGE
- B 9 British Artilleryman, skeleton equipment, kneeling holding shell
- B 10 British Artillery N.C.O., skeleton equipment, with binoculars
- B 11 British Artilleryman, skeleton equipment, manning gun
- B 12 British Artillery Officer, skeleton equipment, with map board



Having nearly completed the predicted issues from our Blue list rest assured that we are in the throes of preparing our new catalogue which will include items of interest for everyone. In the meantime, you Ancient fans, note that we are giving separate wire spears, etc., to go with your figures. They should present no difficulties, a touch of glue into the hand, a gentle squeeze over and you've got more of the realism you have come to expect from us. More in 'Military Modelling' — next issue.

Our new complete lists are available now — 5p — from your local stockist, or in case of difficulty send S.A.E. and 5p. TRADE INQUIRIES WELCOMED.

Early 70ies Hinchliffe was making 25mm and 20mm plus a range of guns in 54mm, those guns were made to be used with the artillery teams made by producers such as Rose Miniatures, Traditions, Hinton Hunt

But quickly they will also make full teams with horses, canon and limbers

Au début des années 70, Hinchliffe fabriquait des figurines 25mm et 20mm, ainsi que de l'artillerie en 54mm pour accompagner les figurines 54mm fabriquées par d'autres comme Rose Miniatures, Tradition, Hinton Hunt

Rapidement, ils fabriqueront des sets complets avec chevaux, canon et caissons .

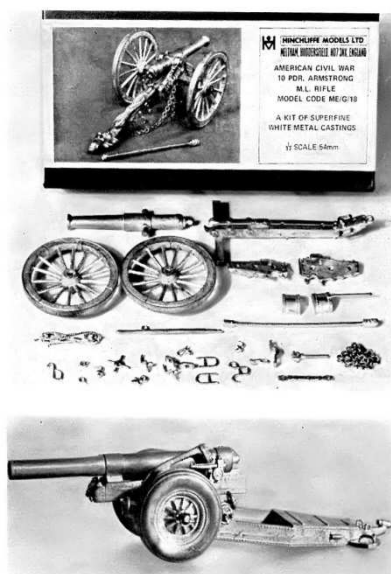

Here presentation of a gun in kit

Presentation d'un canon en kit



HINCHLIFFE MODELS

MELTHAM, HUDDERSFIELD, HD7 3NX, ENGLAND.

NEW RELEASES — OCTOBER 1972

25 mm RANGE

BRITISH NAPOLEONIC CAVALRY (BNC)
BNC18 RHA Rocket Troop, Mounted Officer
BNC20 Infantry Officer, Mounted

FRENCH NAPOLEONIC CAVALRY (FNC)
FNC29 Mounted Infantry, Colonel

BRITISH COLONIAL (BC)
BC13 Highland Infantry, Private, advancing
BC14 Highland Infantry, Private, kneeling firing
BC15 Highland Infantry, Private, lying firing
BC16 Highland Infantry, Officer

BRITISH COLONIAL CAVALRY (BCC)
BCC4 Bengal Lancer, Officer

ROMAN (AR)
AR6 Cornicer
AR7 Standard Bearer

ROMAN CAVALRY (ARC)
ARC2 Light Cavalry Officer
ARC4 Moorish Light Cavalry

SASSANID PERSIANS (AS)
AS3 Mercenary Light Infantry with sling

GREECE (AG)
AG3 Cretan Archer
AG4 Agrianian Javelinman

EQUIPMENT GROUPS (EG)
EG2 British Colonial 2.5" (screw) gun and four firing crew
EG3 Persian War Chariot with driver, warrior and two horses
EG5 British Colonial three-man Heliograph group

25 mm EQUIPMENT RANGE (25)
25/AD 10 Mina Onager (stone-throwing catapult)

Foot Figures Cavalry Equipment



20 mm RANGE

A2 American Infantry Advancing, combat order
A3 American Infantry N.C.O., combat order, advancing
A4 American Infantry, combat order, kneeling, firing
A5 American Infantry Officer, combat order, with binoculars

20 mm EQUIPMENT RANGE (20)
20/25 German W.W.II 7.5 cm PAK40 L/46



HANOVERIAN JAGER
(SCHARFSCHUTZ)
RIFLE REGIMENT
VON KIELMANSEGGE JAGER CORPS
1815

Announcing our new uniform print cards. These are in sets of three cards in a separate folder as per illustration, full painting details are carried on the reverse of the folder.

Produced by Northern Military Art with the full co-operation of Hinchliffe Models they represent the finest value available. The first set comprises:

Hanoverian Jager (Scharfschultz)
Rifle Regiment
Von Kielmansegge Jager Corps 1815 (illustrated)

Private
Line Fusilier (Dutch)
Dutch-Belgian Infantry 1815

Trooper
Prussian Line Dragoons
Neumarkisches No. 7 Regiment 1815

RETAIL PRICE 18p

WE ARE NOW AGENTS FOR THE FAMOUS BOOKS OF PHIL BARKER PUBLISHED BY THE WARGAMES RESEARCH GROUP, a must for the Ancients Wargamer and Collector. They provide the most concise guide to uniform data, weapons, tactics, etc. — fully illustrated, complete text.

The Armies and Enemies of Imperial Rome 150BC to AD600
— £1.75

Armies of the Macedonian and Punic Wars 350 to 150BC
— £1.30

WE WISH TO ANNOUNCE THE FORMATION OF A NEW CANADIAN AGENCY

**HINCHLIFFE MODELS CANADA
37 HAMPSHIRE HEIGHTS
ISLINGTON, ONTARIO**

ALL CANADIAN TRADE OR DIRECT MAIL INQUIRIES WELCOMED

NEW 54 mm MODEL RELEASES

ME/G/11 British 10" Howitzer 1840 period (one of the the heavies of the Crimea era)

ME/G/13 British W.W.I 13 pdr. Field Gun (the gun used at the present day by the Kings Troop R.H.A.)

ME/G/14 British 6 pdr. gun Waterloo/Crimea (essentially the same model as ME/G11 with a different barrel)

COMPLETE LISTS ARE AVAILABLE — 5p — FROM YOUR LOCAL STOCKIST OR IN CASE OF DIFFICULTY SEND S.A.E. PLUS 5p. TRADE INQUIRIES ON ALL ABOVE ITEMS WELCOMED.



HINCHLIFFE MODELS

MELTHAM, HUDDERSFIELD, HD7 3NX, ENGLAND.

NEW RELEASES — JULY 1972 25 mm RANGE

FRENCH NAPOLEONIC CAVALRY (FNC)

- FNC 23 Grenadier à Cheval of the Guard, Trooper
- FNC 24 Grenadier à Cheval of the Guard, Officer
- FNC 25 Grenadier à Cheval of the Guard, Trumpeter
- FNC 26 Chasseur à Cheval of the Guard, Trooper holding carbine at rest
- FNC 27 Chasseur à Cheval of the Guard, Officer
- FNC 28 Chasseur à Cheval of the Guard, Trumpeter

FRENCH NAPOLEONIC (FN)

- FN 61 Foot Artillery of the Guard, with rammer
- FN 62 Foot Artillery of the Guard, with portfire
- FN 63 Foot Artillery of the Guard, carrying a bucket
- FN 64 Foot Artillery of the Guard, holding drag rope
- FN 65 Foot Artillery of the Guard, Officer

DUTCH, BELGIAN NAPOLEONIC CAVALRY (DBNC)

- DBNC 1 Carabinier, Trooper
- DBNC 2 Carabinier, Officer
- DBNC 3 Carabinier, Trumpeter

RUSSIAN NAPOLEONIC (RN)

- RN 6 Line Grenadier, advancing
- RN 7 Line Grenadier, Officer
- RN 8 Line Grenadier, Drummer

RUSSIAN NAPOLEONIC CAVALRY (RNC)

- RNC 3 Dragoon Trooper
- RNC 4 Dragoon Officer
- RNC 5 Dragoon Trumpeter

BRITISH NAPOLEONIC CAVALRY (BNC)

- BNC15 Light Dragoon Trooper
- BNC16 Light Dragoon Officer
- BNC17 Light Dragoon Trumpeter

PRUSSIAN NAPOLEONIC (PN)

- PN18 Gunner, quenching sponge
- PN19 Gunner, carrying round
- PN20 Gunner, pulling on wheel spokes
- PN21 Gunner, with portfire and linstock
- PN22 Gunner, officer

AUSTRIAN NAPOLEONIC CAVALRY (ANC)

- ANC 1 Cuirassier Trooper
- ANC 2 Cuirassier Officer
- ANC 3 Cuirassier Trumpeter

PERSONALITY FIGURES (PF)

- PF 7 Field Marshal Prince Blucher
- PF 8 General Count von Gneisenau
- PF 12 General Kutsov
- PF 13 Duke of Brunswick
- PF 14 Marshal Berthier, Chief of Staff

LIGHT HORSES (LH)

- LH 6 Light Horse, head down, grazing
- LH 7 Light Horse, shaggy coat, galloping

EQUIPMENT HORSES (EH)

- EH5A British Nap. Limber Horse, unriden, standing, head thrown up
- EH5B British Nap. Limber Horse, ridden, standing, head down

25 mm EQUIPMENT RANGE (25)

- 25/AA British Napoleonic 18PDR Naval gun
- 25/AB British Napoleonic 18PDR gun on wooden garrison carriage

20 mm RANGE

- 20/23 German W.W.II 150 mm. Nebelwerfer 75p
- 20/26 German W.W.II 8.8 cm. PAK 43/31 L/71 75p

Foot Figures Cavalry Equipment



30 mm RANGE

Offered now in KIT form they are the ideal size not only for the collector or wargamer but also for he or she who likes to have the odd collectors' piece about home or office. They offer superb detail and authenticity for a modest outlay.

- 30/ 1 British 9-pdr. gun Napoleonic/ Crimea 75p
- 30/ 2 British Limber Napoleonic/ Crimea 75p
- 30/ 3 British 3-pdr. Galloper gun 1700-1790 75p
- 30/ 4 British 24-pdr. gun 1700-1790 75p
- 30/ 5 British 8 in. Howitzer 1700-1790 75p
- 30/ 6 British Limber 1700-1790 40p
- 30/ 7 British Pontoon Wagon 1700-1790 80p
- 30/ 8 French Napoleonic 8-pdr. gun 80p
- 30/ 9 French Napoleonic 12-pdr. gun 80p
- 30/11 British 6-pdr. gun Napoleonic 75p
- 30/12 British Spare Wheel Carriage Napoleonic/Crimea 75p

Our next releases will include 25 mm. ANCIENTS, more 25 mm. Napoleonics, more 20 mm. W.W.II and the odd piece of 25 mm. equipment. We still measure our figures from the soles of their feet to the top of their heads, we still believe all men were of slightly differing height and we are pleased to say that more and more valued customers are agreeing with us. To you all, we say thank you and may you continue to support your retailer wherever possible.

Our new complete lists are available now — 5p — from your local stockist, or in case of difficulty send S.A.E. and 5p. TRADE ENQUIRIES WELCOMED.



HINCHLIFFE MODELS

MELTHAM, HUDDERSFIELD, HD7 3NX, ENGLAND.

NEW RELEASES—DECEMBER 1972 25 mm RANGE

FRENCH NAPOLEONIC CAVALRY (FNC)

- FNC 15 Hussar holding Carbine
- FNC 30 Empress Dragoons Trooper
- FNC 31 Empress Dragoons Officer
- FNC 32 Empress Dragoons Trumpeter

BRITISH NAPOLEONIC CAVALRY (BNC)

- BNC 21 Hussar Trooper
- BNC 22 Hussar Officer
- BNC 23 Hussar Trumpeter

AMERICAN CIVIL WAR (ACW)

- ACW 18 Garibaldi Guard, Private 39th N.Y.
- ACW 19 Iron Brigade, Private
- ACW 20 Confederate Trooper, dismounted, kneeling, firing Carbine

EQUIPMENT HORSES (EH)

- EH6 A American Civil War Limber Horse, standing, head normal, unriden
- EH6 B American Civil War Limber horse, standing, head normal, ridden

25 mm. ANCIENT RANGE

ACHAEMENIAN PERSIAN (AP)

- AP 1 Archer
- AP 2 Immortal
- AP 3 Officer





HINCHLIFFE MODELS

MELTHAM, HUDDERSFIELD, HD7 3NX, ENGLAND.

NEW RELEASES — MARCH 1973 25 mm RANGE

**Foot Figures
Cavalry
Equipment**



BRITISH NAPOLEONIC (BN)

BN12 Light Infantry — kneeling firing
BN19 Rifleman — kneeling firing
BN31 Highland Ensign — with colours

PRUSSIAN NAPOLEONIC (PN)

PN3 N.C.O. with colours

ANCIENT ROMAN (AR)

AR12 Barbarian Synnachiarius
AR16 Byzantine heavy infantry

ANCIENT GREEK CAVALRY (AGC)

AGC1 Companion cavalryman

AGC2 Dahae horse archer

PALMYRIAN CAVALRY (PAC)

PAC1 Cataphract

PAC2 Regular light cavalry

ANCIENT BRITONS (AB)

AB1 Slinger

AB3 Javelinman

ANCIENT HORSES (AH)

AH6 Hun pony — head up

AH7 Medium cavalry horse

!! 54 mm BRITISH NAPOLEONIC GUN TEAM AND RIDERS !!

6 or 4 HORSE TEAM

An infinite variety of positions can be obtained — Interchangeable horse and rider positions, horse heads and tails interchangeable, riders' heads are precise fit plug-in type. Separate stirrups, reins, saddles, etc.

H/G Near wheel horse

H/J Off centre horse

H/H Off wheel horse

H/K Near lead horse

H/I Near centre horse

H/L Off lead horse

R1 British Napoleonic. Driver, Royal Corps of Drivers — both hands on reins.

R2 British Napoleonic. Driver, Royal Corps of Drivers — right arm extended with whip.

R3 British Napoleonic. Driver, Royal Corps of Drivers — half turned in saddle.

HORSES £1.20 each

RIDERS 90p each

ALSO AVAILABLE — W.W.I HARNESSSED TEAM £1.20 per horse

Catalogue available 30p from your retailer, 33p direct.
Trade inquiries welcomed.



Rorke's Drift

La superbe série en 54mm sculptée par Sanderson commence

The superb range 54mm sculpted by Sanderson begins



Mirof 1973



HINCHLIFFE MODELS LTD.

MELTHAM, HUDDERSFIELD, HD7 3NX, ENGLAND



From the hands of Ray Lamb we are proud to present the first of our Ray Lamb Originals, a new departure in that we shall not be held to any specific size or subject in the future. Although widely acclaimed as the ultimate in figure design, we take this opportunity of reminding you that this is the **FIRST** ever figure designed by Ray for reproduction.

After its description in subsequent pages of this magazine it requires no further introduction from us.
JAPANESE TAISHO, RLO/1 £9.90 inc. V.A.T.



From the same talented and magic hands of Ray Lamb comes yet another breakthrough in the world of model soldiers. Designed to fit in with the present trends, we bring to you a combination of design and casting never before achieved in what we hope will be an expanding range to include mounted figures and the same matching equipment models you associate with us. A few months ago we all thought nothing new could fire the military modelling scene – see the three new figures at your local stockists and note for yourself the charm and character never before seen. Complete with colour instructions etc., in English, French, and German.

- 75/1 Tambour de Fusiliers 1805-1806
- 75/2 Grenadier de Ligne 'tenue de route' 1805/1807
- 75/3 Grenadier de Ligne 'tenue de combat' 1807

Introducing yet another new designer to our team, we present two more 54 mm figures from the capable and talented DAVE SPARROW, another well-known modeller who is soon to be more widely acclaimed.

- C4 BRITISH LIFE-GUARDS TROOPER 1815 Dismounted with horse.....**£2.42 inc. V.A.T.**
- C5 BRITISH, NORTH BRITISH DRAGOONS 1815 Royal Scots Grey Trumpeter...**£2.42 inc. V.A.T.**

Introductions to our 25 mm figure designer are hardly necessary as PETER GILDER proudly presents the latest additions to his superb range of war gamer/collector figures. He introduces a new range this month and another, completely new range next month which is beyond our superlatives . . .

The French have a saying for all this – très formidable – we think it means hard, honest endeavour with a lot of enjoyment for you all!

RORKE'S DRIFT PERIOD

- BC24 British Inf. Standing Firing.
- BC25 British Inf. Kneeling Firing.
- BC26 British Inf. Advancing.
- BC27 British Inf. Officer.
- BC28 Zulu with rifle.

- BC29 Zulu Chief.
- BC30 Zulu stabbing.

VIKINGS

- AV1 Baresark with sword and axe.
- AV2 Bowman.
- AV3 Mailed Swordsman.

To our American friends we say 'watch out for us, we're coming over there in a big way!' Support our agents below and be around when it happens.

Miniature Figurines U.S.A. Inc.,
 4311 Lemmon Avenue,
 Dallas, Texas 75219.

Coulter Bennett Ltd.,
 12158 Hamlyn Street, Suite 1,
 North Hollywood, California 91606.

On sale now at your local stockist – or direct if any difficulty is experienced in obtaining supplies.

Illustrated catalogue 35p.

New up-to-date **Blue List** 5p + s.a.e.

NEW!
75 mm RANGE
NEW!



All at £2.25 inc. V.A.T.



75mm Ray Lamb painted in the 70ies MiRof mainly with Humbrol



HINCHLIFFE MODELS LTD.

MELTHAM, HUDDERSFIELD, ENGLAND HD7 3NX

DECEMBER 1973

NEW 25 mm RANGE LIST

FRENCH NAPOLEONIC (FN)

FN31 French dismounted dragoon, firing

FRENCH NAPOLEONIC CAVALRY (FNC)

FNC41 Carabinier at rest

FNC42 Carabinier Officer at rest

GREECE (AG)

AG6 Successor Phalangite

AG7 Mercenary Peltast with Thureus

AG8 Rhodian Slinger

GREEK CAVALRY (AGC)

AGC3 Selucid Arab Camelman - 25p

SASSANID PERSIAN CAVALRY (ASC)

ASC4 Clibanarius, charging

ASC5 Cataphract, charging

ANCIENT HORSES (AH)

AH12 Half armoured horse, galloping

AH13 Cataphract horse, rearing

EQUIPMENT GROUP (EG)

EG8 Macedonian War Elephant, driver and three men - £1.02



Foot Figures Cavalry Equipment

54 mm FIGURE RANGE

54mm FOOT FIGURES

F3 British Victorian, Gunner at drill, holding rammer 90p

F4 British Victorian, Gunner at drill, with hand lever 90p

F5 British Victorian, Gunner at drill, holding round 90p

F6 British Victorian, Gunner at drill, standing to gun 90p

F7 British Victorian, Gunner Officer, at drill 90p

F17 British Royal Scots Grey Trooper, on foot, in stable dress 90p

These figures are suitable for use with our 54mm models ME/G/10 and ME/G/11

75 mm FIGURE RANGE

75mm FIGURES (75)

75/6 French Officer de Grenadiers, tenue de service 1804-1810 nonchalant pose, holding bearskin, foot on rock £2.25

75/7 French Grenadier de ligne en tenue de route 1805-1807 standing holding musket, wearing bonnet de police £2.25

OUR NEW ILLUSTRATED, UP-TO-DATE CATALOGUE AVAILABLE 50p FROM YOUR RETAILER, 58p DIRECT



HINCHLIFFE MODELS LTD.

MELTHAM, HUDDERSFIELD, ENGLAND HD7 3NX

March 1974 additions to Range

25mm FIGURES

French Napoleonic Cavalry (FNC)

FNC42 Carabinier at rest

English Civil War Cavalry (ECWC)

ECWC7 Light Cavalry plumed hat, Officer

Greece (AG)

AG7 Mercenary Peltast with Thureus

54mm FOOT FIGURES (F)

F1 British Napoleonic, Driver of train, on foot

F20 French Napoleonic Horse Artillery of the Guard, Gunner sponging out gun

F21 French Napoleonic Horse Artillery of the Guard, Gunner carrying buckets

F22 French Napoleonic Horse Artillery of the Guard, Gunner carrying round

F23 French Napoleonic Horse Artillery of the Guard, Gunner standing to gun

F24 French Napoleonic Horse Artillery of the Guard, Gunner with linstock

F25 French Napoleonic Horse Artillery of the Guard, Gunner kneeling to ammunition chest

F26 French Napoleonic Horse Artillery of the Guard, Officer

75mm FIGURES (75)

75/13 French Grenadier de ligne en tenue de route 1805-07, in bicorne, knelt on one knee holding musket

75/16 French Grenadier de ligne en tenue de service, 1805-07, in bearskin, bicorne in pack ramming musket

75/17 French Grenadier de ligne en tenue de route 1805-07, in bonnet de police, knelt on one knee holding musket

75/19 French Grenadier de ligne en tenue de route 1805-07, wearing bonnet de police, and plain pack with blanket roll, ramming musket

75/20 French Grenadier de ligne en tenue de service 1805-07, wearing bonnet de police, and plain pack with blanket roll, biting cartridge

75/21 French Grenadier de ligne en tenue de service 1805-07, in bearskin, bicorne in pack, kneeling on one knee holding musket



ILLUSTRATED CATALOGUE AVAILABLE 50p FROM YOUR LOCAL STOCKIST OR 60p DIRECT FROM HINCHLIFFE MODELS LTD.



HINCHLIFFE MODELS LTD.

MELTHAM, HUDDERSFIELD, ENGLAND HD7 3NX

May 1974 additions to Range

75mm FIGURES (75)

75/18 French Tambour de Grenadiers, nonchalant pose, drum slung in position.

54mm FOOT FIGURES (F)

F27 British W.W.I. gunner carrying shells in canvas yoke.

25mm BRITISH NAPOLEONIC (BN)

BN32 Rifleman running rifle at trail.

BN34 Line Sergeant.

BN40 Guard Light Company, standing firing.

BN41 Guard Light Company, advancing.

BN42 Guard Light Company Officer, advancing.

Our recent 25mm releases have reached such high standards of design that we have decided to remake many of our earlier figures.

Below is a list of the chosen remakes and we hasten to assure our past customers that, although they are infinitely better in all respects, they will be very compatible with all earlier figures of the same code number.

BN1	BN10	BN17	BN24	BN57	FN41
BN2	BN11	BN18	BN40	BN58	FN42
BN3	BN13	BN20	BN55	BN60	FN43
BN5	BN14	BN23	BN56	FN40	FN45
BN6	BN16				



ILLUSTRATED CATALOGUE AVAILABLE 50p FROM YOUR LOCAL STOCKIST OR 60p DIRECT FROM HINCHLIFFE MODELS LTD.

June 74

Get to know **HINCHLIFFE**



Hinchliffe manufacture the finest white metal cast military figures and equipment models in the world, with superb craftsmanship, authenticity and attention to detail. Ideal for war games – the best battles are fought with Hinchliffe!

The vast Hinchliffe range embraces many exciting historical periods including :-

20mm Figures and Equipment. Second World War.

25mm Figures, Equipment and Horses. Napoleonic, British Colonial, American Civil War, English Civil War, Ancients.

25mm Personality Figures. Napoleon, Wellington, General Lee, etc.

54mm Figures and Equipment. British Napoleonic, Crimean, World War 1.

75mm French Napoleonic foot figures.

The unique **Japanese Samurai Taisho Warrior** (approx. 6½" high).



For the best possible results Hinchliffe recommend Humbrol Military Colours and Britfix "5 minute" epoxy adhesive.



Write for a current Price List (6p) or detailed Catalogue (60p) to:

HINCHLIFFE MODELS LIMITED
Meltham, Huddersfield, England, HD7 3NX.



HINCHLIFFE MODELS LTD.

MELTHAM, HUDDERSFIELD, ENGLAND HD7 3NX

June 1974 additions to Range

BRITISH NAPOLEONIC (BN)

- BN33 Fusilier Ensign with colours
- BN35 Fusilier Sergeant
- BN36 Fusilier Drummer
- BN37 Highland Sergeant
- BN38 Highland Drummer
- BN39 Highland Piper
- BN43 Line Infantry at rest
- BN44 Line Infantry marching

ENGLISH CIVIL WAR CAVALRY (ECWC)

- ECWC9 Cuirassier
- ECWC10 Cuirassier officer

54 mm. FOOT FIGURES (F)

- F28 American Civil War Confederate Artillery Officer
- F29 American Civil War Confederate Artillery Sergeant
- F30 American Civil War Confederate Artilleryman pulling firing lanyard
- F31 American Civil War Confederate Artilleryman with fuse satchel
- F32 American Civil War Confederate Artilleryman carrying buckets
- F33 American Civil War Confederate Artilleryman with rammer
- F34 American Civil War Confederate Artilleryman carrying round of ammunition



ILLUSTRATED CATALOGUE AVAILABLE 50p FROM YOUR LOCAL STOCKIST OR 60p DIRECT FROM HINCHLIFFE MODELS LTD.



HINCHLIFFE MODELS LTD.

MELTHAM, HUDDERSFIELD, ENGLAND HD7 3NX

July / August 1974 additions to Range

NEW 25mm MEDIEVAL RANGE

Medieval (MF) – including Crusades

- MF3 11th-12th Century Crossbowman, firing.
- MF4 11th-12th Century Armoured Infantry, advancing with spear.
- MF6 11th-12th Century Armoured Infantry, advancing with sword.
- MF7 11th-12th Century Armoured Infantry at rest with Halbard.

Medieval Cavalry (MC)

- MC3 11th-12th Century Crusader, charging with lance (MH2 MH3).
- MC5 11th-12th Century Saracen horse archer (MH5)
- MC6 11th-12th Century Saracen armoured cavalry (MH5).

Medieval Horses (MH)

- MH2 11th-12th Century Crusader horse, galloping.
- MH5 11th-12th Century Light horse, galloping.

Personality Figures (PF)

- | | |
|--------------------------------------|--------------------------------|
| PF18 'Jeb' Stuart. | PF24 Alexander the Great. |
| PF19 'Stone Wall' Jackson | PF25 Chosroes II (Sassanid). |
| PF20 General Nansouty (Cuirassiers). | PF26 Belisarius (Byzantine). |
| PF21 General Lasalie. | PF27 Attila the Hun. |
| | PF28 Constantine (Late Roman). |
| | PF29 Aurelius (Imperial Rome). |



54mm RANGE

54mm CAVALRY (C)

- C8 Chasseur à Cheval of the Guard Officer, standing by horse.

54mm Artillery Riders (R)

- R7 British Napoleonic Royal Horse Artilleryman, Limber or Ammunition wagon rider.

54mm Foot Figures (F)

- F42 British Napoleonic Guard Infantryman, standing in nonchalant position.

54mm Foot Figures (F)

- F43 British Napoleonic Guard Sergeant, standing in nonchalant position.

75mm RANGE

75mm Figures (75)

- 75/29 British 71st (Highland) Light Infantry Private, standing in an 'on guard' position.
- 75/30 British 27th (Inniskilling) Private, standing in an 'on guard' position.
- 75/31 W.W.II. Waffen SS Panzer Grenadier advancing, entrenching tool and stick grenade in hands, schmeisser pistol slung round neck.
- 75/32 French Grenadier de line en tenue de route 1805-07, wearing bonnet de police and plain pack with blanket roll, standing firing musket.
- 75/33 French Grenadier de line en tenue de route 1805-07, wearing bearskin, bicorne in pack, standing firing musket.
- 75/34 French Grenadier de line en tenue de route 1805-07, wearing bicorne, bearskin in bag above pack, standing firing musket.
- 75/35 W.W.II. Panzer Grenadier in casual stance holding machine pistol.

AMERICAN WARGAMERS & COLLECTORS

The manufacturer of our products is at your service from the capable hands of Miniature Figurines U.S.A. Inc., 4311 Lemmon Avenue, Dallas, Texas 75219, U.S.A. To whom all your inquiries should be addressed, trade inquiries welcomed.



Please note –
25mm foot now 9p. Cavalry 10p.
Horses 11p. 54mm foot and
artillery riders £1.13.



HINCHLIFFE MODELS LTD.

MELTHAM, HUDDERSFIELD, ENGLAND HD7 3NX

October 1974 additions to range

54 mm EQUIPMENT

ME/G/15 British Colonial 2.5 in RML gun (screw gun)

ME/G/19 Gatling Gun U.S. Model 1865

54 mm FOOT FIGURES (F)

F44 Havildar standing with binoculars

F45 Indian Gunner kneeling by gun

F46 Indian Gunner kneeling with shell

F47 Indian Gunner crouching over hand spike

F48 Indian Gunner kneeling with ramrod

F49 U.S. Union Soldier cranking Gatling Gun

F50 U.S. Union Soldier with Gatling Gun magazine

F53 Guards Drummer Boy 1815 in nonchalant pose on campaign

75 mm FIGURES (75)

75/37 95th Rifleman 1815 in nonchalant pose



ILLUSTRATED CATALOGUE AVAILABLE 50p FROM YOUR LOCAL STOCKIST OR 60p DIRECT FROM HINCHLIFFE MODELS LTD.

We recommend

HUMBROL AUTHENTIC
MILITARY COLOURS

for all our products

Nov 74



HINCHLIFFE MODELS LTD.

MELTHAM, HUDDERSFIELD, ENGLAND HD7 3NX

25 mm American War of Independence Cavalry (AWC)

- AWC1 Artillery driver on lead horse*
- AWC2 British light dragoon on galloping horse*
- AWC3 British light dragoon Officer*
- AWC4 British light dragoon Trumpeter *
- AWC5 British light dragoon, firing carbine*

The uniform of the continental line and the British Battalion Company was so much the same in design that figures listed as line infantry can be used equally for American or British and the same can be said for the artillery crews of the British and American armies.

This range sees the introduction of the combination cavalry figure, horse and rider cast integral. This has been asked for by many of our customers and, where the position of the rider is suitable, then this will be done.

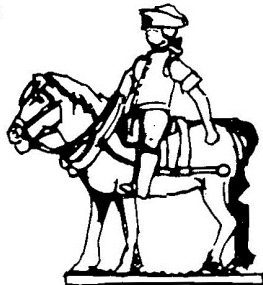

AWC1

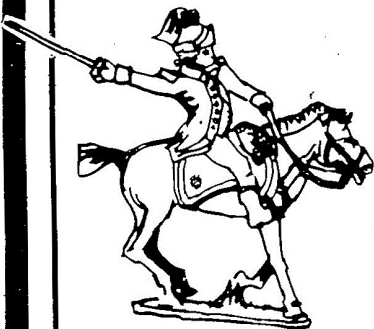

AWC3

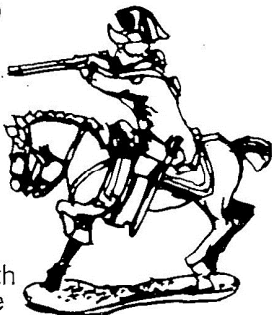

AWC5

*Cavalry figures of this type will be marked with an asterisk in our future literature.

PRICE 20p

75 mm Foot Figures (75)

75/38 Anatolian Auxiliary Infantryman

75 mm Cavalry Figures (75C)

PRICE £6.25 including V.A.T.

75/C1 Assyrian lancer

75/C2 Assyrian medium horse archer

90 mm Figures (90)

PRICE £3.30 including V.A.T.

90/1 Prussian Grenadier 1812

90/2 Prussian Landwehr Infantry 1814

90/3 Cleve-Burg: Infantry Officer 1812



Benassi

54 mm Foot Figures (F)

F51 Chasseur a Cheval Officer wearing pelisse

F52 Chasseur a Cheval NCO in Sunday dress

F54 Farrier R.H.A. 1815

F55 Guards Sergeant in Greatcoat 1815

WISHING ALL OUR
CUSTOMERS
A MERRY CHRISTMAS
AND A
HAPPY NEW YEAR

NEW IN 75MM.

Feb 75

- 75/37 95TH RIFLEMAN 1815 IN NONCHALANT POSE.
- 75/38 ANATOLIAN AUXILIARY INFANTRYMAN.
- 75/C1 ASSYRIAN LANCER (Illus. below).
- 75/C2 ASSYRIAN MEDIUM HORSE ARCHER (Illus. right).
- 75/C3 PLAINS INDIAN SQUATTING BESIDE HORSE, WEARING BUFFALO HEADADDRESS.
- 75/C4 MOUNTED PLAINS INDIAN.



HINCHLIFFE MODELS LTD.

MELTHAM, HUDDERSFIELD, ENGLAND HD7 3NX



HINCHLIFFE MODELS LTD.

MELTHAM, HUDDERSFIELD, ENGLAND HD7 3NX

Feb 75



WAITING TO GO FORWARD!

It could be PASSCHENDAELE, it could be CAMBRAI. The realism of this World War I 18 pdr. gun team belongs to any modeller who cares to go forward with HINCHLIFFE. An *'oldie'* from real life, an *'oldie'* from our range and, like the real thing, it's never been bettered.

Some artillery team / Quelques sets d'artillerie

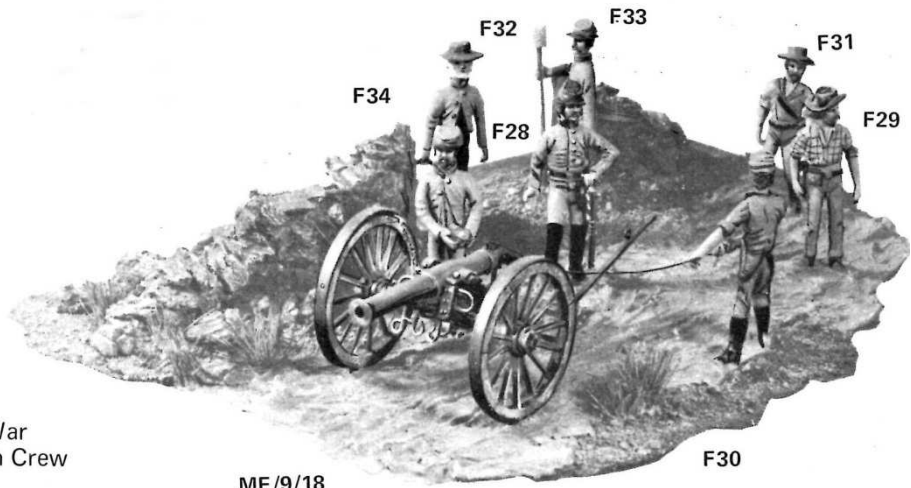

American Civil War
Confederate Gun Crew

ME/9/18

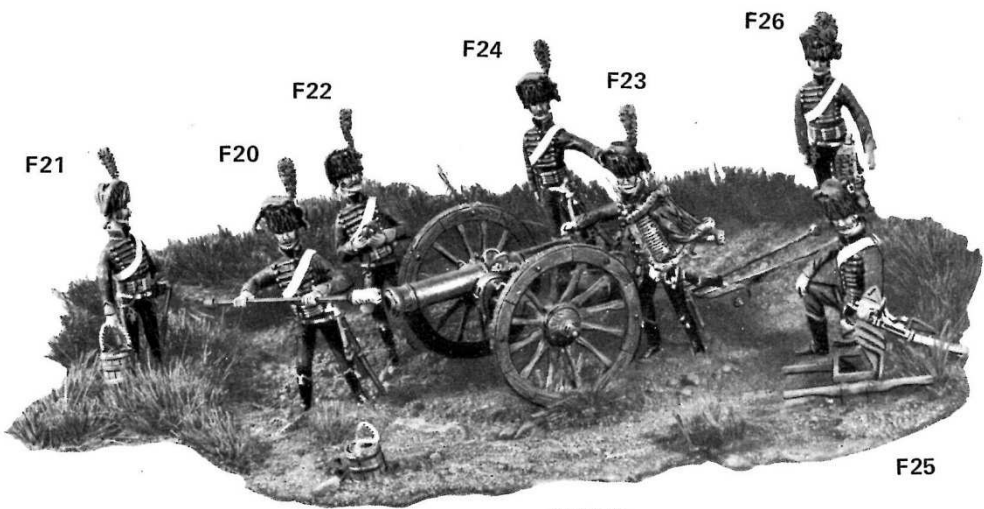

ME/9/6

French Napoleonic
Horse Artillery of the
Guard Gun Crew



HINCHLIFFE MODELS LTD.

MELTHAM, HUDDERSFIELD, ENGLAND HD7 3NX

February 1975 additions to range

This month sees the introduction of our new Science Fiction range based on the Martian Books of Edgar Rice Burroughs.

A mixture of both man and animal, sword and radium gun, these beings and their war-like civilisation blend together to make the ideal fantasy Wargame series.

Science Fiction (SF)

SF1	Red Martian Chief	9p
SF2	Red Martian Warrior, radium rifle	9p
SF3	Red Martian Warrior, sword and dagger	9p
SF4	Red Martian Maiden with pistol	9p
SF5	Black Martian, radium rifle	9p
SF6	White Martian Chief	9p
SF7	White Martian Warrior, sword	9p
SF8	Green Martian Chief	18p
SF9	Green Martian Warrior	18p
SF10	John Carter – Martian War Lord	9p
SF11	Red Martian Princess	9p
SF12	White Ape with Club	18p
SF13	Plant Man	18p
SF14	Martian Lion	11p
SF15	Martian Dog	11p
SF16	Red Martian mounted on Thoat	27p
SF17	Green Martian on large Thoat	54p



PAC 4
Palmerian
Camelman
25mm



EG 8
Macedonian
War Elephant
25mm

54mm American War of Independence (F)

F65	Morgans Rifles
F66	Indian in Military Jacket
F67	Indian on raid
F68	Prussian Grenadier Sergeant
F69	British Officer with Standard

54mm Zulu War Series (CS)

CS7	British 24th Foot Private clubbing with rifle
CS8	British 24th Foot Officer with revolver
CS19	Zulu wounded in prone position with head raised
CS20	Zulu running



HINCHLIFFE MODELS LTD
MELTHAM · HUDDERSFIELD HD7 3NX

Jun 75

the **ZULU WAR** 1879

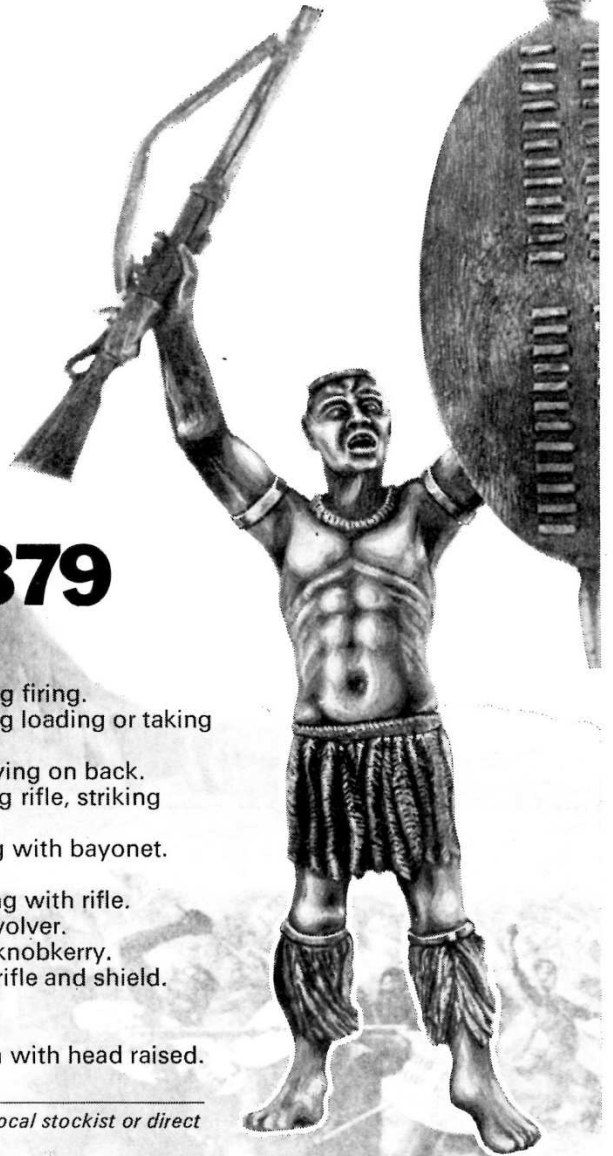

CLIFF SANDERSON RANGE (CS)

- CS1 British 24th Foot Private, standing firing.
- CS2 British 24th Foot Private, standing loading or taking cartridge from pouch.
- CS3 British 24th Foot Private, dead, lying on back.
- CS4 British 24th Foot Private, wielding rifle, striking with butt.
- CS5 British 24th Foot Private, lunging with bayonet.
- CS6 British 24th Foot Private, falling.
- CS7 British 24th Foot Private, clubbing with rifle.
- CS8 British 24th Foot Officer, with revolver.
- CS15 Zulu, with shield and assagai or knobkerry.
- CS16 Zulu, brandishing Martini Henry rifle and shield.
- CS17 Zulu, lying dead.
- CS18 Zulu, thrusting with assagai.
- CS19 Zulu, wounded, in prone position with head raised.
- CS20 Zulu, running

Illustrated catalogue available 50p from your local stockist or direct from Hinchliffe Models Ltd.

*Our manufacturers in the U.S.A: Heritage Models Inc.
2916 Blystone Lane, Dallas, Texas 75220*





HINCHLIFFE MODELS LTD.

MELTHAM, HUDDERSFIELD, ENGLAND HD7 3NX

August 1975 Additions to range

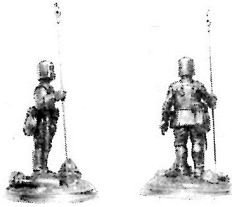

**75/JB1
ITALIAN DEATH
VOLUNTEER,
1917**

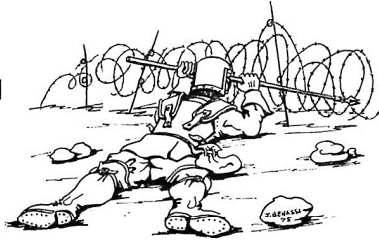

This figure offers something new to the collector. Drawn from the crack units of Ardite and Bersaglieri, the Death Volunteers were formed into groups of special service units to undertake dangerous and daring tasks. In the specially padded gauntlets, overboots and waders, with body armour and helmet and wielding pole extended wire cutters, he looks at first glance to be from a medieval army. However, the helmet and two litre wine bottle at his feet, his Beretta and grenade bag, place him in true perspective and ensure a pride of place in your collection.

A first attempt, this figure makes a secure place for its designer, Major Julian Bennassi, A.M.R., in the ranks of today's figure designers.

Full colouring instructions included — £2.50

ILLUSTRATED CATALOGUE AVAILABLE 50p FROM YOUR LOCAL STOCKIST OR 60p DIRECT FROM HINCHLIFFE MODELS LTD.
Our manufacturers in the U.S.A.: Heritage Models Inc., 2916 Blystone Lane, Dallas, Texas 75220.

25 mm

Russian Renaissance (RE)

- RE17 Russian Streltsi advancing with musket and axe
- RE18 Russian Streltsi firing
- RE19 Russian Streltsi Officer
- RE20 Russian Streltsi drummer
- RE21 Russian Zaporozian infantry with axe
- RE22 Russian Foot Cossack with arquebus

Russian Renaissance Cavalry (REC)

- REC10 Russian Noble cavalryman
- REC11 Russian Noble Officer
- REC12 Russian Noble in mail coat
- REC13 Russian horse archer
- REC14 Russian archer with mace
- REC15 Russian heavy cavalryman

Russian Napoleonic (RN)

- RN2 Standard bearer in greatcoat
- RN10 Pavlov Grenadier standard bearer

Russian Napoleonic Cavalry (RNC)

- RNC6 Cuirassier trooper
- RNC7 Cuirassier Officer
- RNC8 Cuirassier trumpeter
- RNC9 Hussar trooper
- RNC10 Hussar Officer
- RNC11 Hussar trumpeter

75 mm

Julian Bennassi Range (75/JB)

- 75/JB1 Italian Death Volunteer, 1917 —
Rec. Retail Price £2.50

We recommend

HUMBROL AUTHENTIC
MILITARY COLOURS

for all our products



HINCHLIFFE MODELS LTD.

MELTHAM, HUDDERSFIELD, ENGLAND HD7 3NX

OCTOBER 1975 additions to range

25 mm

Napoleonic Peninsular (NP)

- NP 8 British Infantry, Advancing
- NP 9 British Infantry Officer
- NP10 British Infantry Drummer
- NP11 British Ensign with Colours
- NP12 British Rifleman
- NP13 British Rifles Officer
- NP14 British Infantry, charging
- NP15 French Fusilier, advancing
- NP16 French Fusilier, charging
- NP17 French Grenadier, advancing
- NP18 French Line Infantry Officer

Ancient Roman (AR)

- AR22 Late Roman Officer
- AR23 Palatina Auxiliary, with spear
- AR24 Palatina Auxiliary, with bow

Ancient Greek (AG)

- AG10 Greek Officer
- AG11 Greek Standard Bearer
- AG12 Macedonian Phalangite



75/JB/3



75/JB/3

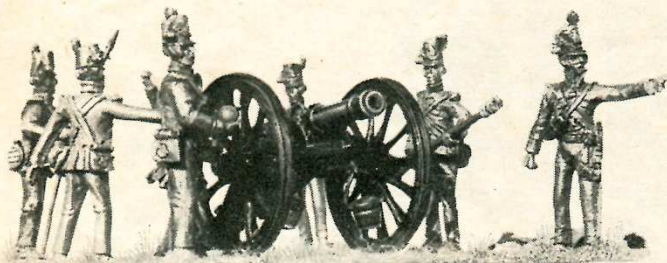

30/DP/3

A superb new range of 30mm figures designed by Dave Sparrow, a designer who is fast acquiring international merit.

Available at the present in handcrafted pewter, these figures are presented only in boxed sets with fully veneered mahogany bases, base material and effects and are complete with information booklets. Where applicable, the artillery equipment is from the already well-known, unbeatable Hinchliffe 30mm range.

Fully acceptable to the established collector, these diorama packs are also ideal for that "don't know what to buy him" present.

30mm Diorama Packs (30/DP)

30/DP2 6 pounder gun and crew (9) of the Royal Horse Artillery 1815.

30/DP3 9 pounder gun and crew (9) of the British Foot Artillery 1815. (as illustrated)

75mm Julian Benassi Range (75/JB)

75/JB3 Bersaglieri 1917 — The Italian Army in the act of demolishing an Austrian frontier post. £3.25

(as illustrated)
75/JB4 Italian Line Infantry Private 1917 — A sentry in the Alps. £2.50 (as illustrated)



75/JB/4

Our manufacturers in the U.S.A.: Heritage Models Inc., 2916 Blystone Lane, Dallas, Texas 75220.

We recommend

HUMBROL AUTHENTIC MILITARY COLOURS

for all our products



HINCHLIFFE MODELS LTD

21 STATION STREET · MELTHAM · HUDDERSFIELD HD7 3NX

Sword and Lance

OCTOBER 1975 ADDITIONS TO RANGE



25mm

30/DP2

Napoleonic Peninsular (NP)

- NP8 British Infantry, advancing
- NP9 British Infantry Officer
- NP10 British Infantry Drummer
- NP11 British Ensign with Colours
- NP12 British Rifleman
- NP13 British Rifles Officer
- NP14 British Infantry, charging
- NP15 French Fusilier, advancing
- NP16 French Fusilier, charging
- NP17 French Grenadier, advancing
- NP18 French Line Infantry Officer

75mm Julian Benassi Range (75/JB)
75/JB3 Bersaglieri 1917 - The Italian Army in the act of demolishing an Austrian frontier post. £3.25



75/JB4 Italian Line Infantry Private 1917 - A sentry in the Alps (as illustrated) £2.50

Ancient Roman 25 mm

- AR22 Late Roman Officer
- AR23 Palatina Auxiliary, with spear
- AR24 Palatina Auxiliary, with bow

Ancient Greek 15 mm

- AG10 Greek Officer
- AG11 Greek Standard Bearer
- AG12 Macedonian Phalangite

30mm Diorama Packs (30/DP)

- 30/DP2 6 pounder gun and crew (9) of the Royal Horse Artillery 1815 (as illustrated)
- 30/DP3 9 pounder gun and crew (9) of the British Foot Artillery 1815

75/JB4



HINCHLIFFE MODELS LTD.

MELTHAM, HUDDERSFIELD, ENGLAND HD7 3NX



TAISSHŌ

(JAPANESE COMMANDER) 12th–13th Century

No collection can be complete without this fabulous all-metal 27 part kit. Still available from Hinchliffe Models Ltd. The kit comes complete with assembly and painting instructions in full colour.

Price £9.72 *plus 25p p.& p.*

We at Hinchliffe Models Ltd. wish you the best for the present season and thank you for your support and interest over the past year. Many new and exciting things are planned for your continuing pleasure in what, we trust, will be a happy and prosperous New Year for you all.

NOVEMBER 1975 additions to range

25mm

Napoleonic Peninsular (NP)

- NP19 Spanish Guerilla, marching
- NP20 Spanish Guerilla, running
- NP21 French eagle bearer
- NP22 French Drummer
- NP23 British marine, advancing
- NP24 British marine officer
- NP25 Portuguese Cacadore, firing
- NP26 Portuguese Cacadore officer

Napoleonic Peninsular Cavalry (NPC)

- NPC5 British Dragoon, in bicorne
- NPC6 British Dragoon Officer
- NPC7 British Light Dragoon
- NPC8 British Light Dragoon Officer

American Civil War (ACW)

- ACW31 Union regular, charging
- ACW32 Union regular officer, charging

Light Horse (LH)

- LH11 Light horse, with tail bow and tassels

30mm

Diorama Packs (30/DP)

- 30/DP4 8pdr. gun and crew (9) French Napoleonic Horse Artillery of the Guard
- 30/DP5 12pdr. gun and crew (9) French Napoleonic Foot Artillery of the Line

54mm

Cliff Sanderson Range (CS)

- CS23 Serving girl with tray. (Ideal to group with CS21 and CS22 and tavern scenes of most periods)

Please write for our current price list, 12p.

Our manufacturers in the USA.: Heritage Models Inc., 2916 Blystone Lane, Dallas, Texas 75220

We recommend

HUMBROL AUTHENTIC
MILITARY COLOURS

for all our products

Talk Military Collecting
and you talk of —

HINCHLIFFE

The Best in

Feb 76

PRODUCTION QUALITY AND DESIGN

Sanderson

Couple this to our renowned ability to deliver the goods and you're talking about the best in this top field of military modelling.

Over 400 stockists throughout the country can't be wrong! (An S.A.E. brings you the address of your nearest.)

See what you get before you buy and become another of our personal and satisfied customers.

REMEMBER, GOOD MODELLING STARTS WITH —



HINCHLIFFE MODELS LIMITED.
Meltham, Huddersfield,
England HD7 3NX



54mm Spanish Peninsular
CS21 and CS22 (Now
available to complement
these figures is CS23, a
serving girl with tray.)

And some Benassi 75mm / Et quelques Benassi 75mm



Extraits de Military Modelling Apr 1976

Military Modelling extracts Apr 1976

"The Model of Julian Benassi pages 230 – 232"



HINCHLIFFE MODELS LTD

MELTHAM, HUDDERSFIELD, ENGLAND HD7 3NX



75/JB5

February 1976 additions to range

- 25mm**
Napoleonic Peninsular (NP)
 NP27 Spanish Fusilier in bicorne
 NP28 Spanish Standard Bearer
- French Napoleonic (FN)**
 FN38 Polish Voltiguer, advancing
- French Napoleonic Cavalry (FNC)**
 FNC48 Empress Dragoon Standard Bearer 18p
 FNC49 Chasseur à Cheval Standard Bearer 18p
- British Napoleonic Cavalry (BNC)**
 BNC24 Scots Grey Guidon Bearer 18p
- American War of Independence (AW)**
 AW37 Butlers Ranger
 AW38 Iroquois Indian
 AW39 American Infantry, charging
 AW40 Minute man, advancing
 AW41 American Militia, advancing
 AW42 British Colour Bearer

- AW43 American Colour Bearer
 AW44 Brunswick Colour Bearer
- 25mm Equipment (25/)**
 25/AW Pair of oxen and yoke 29p
- 25mm Equipment Group (EG)**
 EG12 Ox cart, 2 oxen and driver on foot. Suitable for all periods. 88p
- 54mm**
Cliff Sanderson Range (CS)
 CS24 Woman charging musket from powder flask 1800-1900
 CS25 Woman ramming musket with child clinging to skirts 1800-1900
- 75mm**
Julian Benassi Range (75/JB)
 75/JB5 Captain of Grenadiers, 7th 'Africa' Line Regiment, Naples 1812 £2.50
- Julian Benassi Cavalry Range (75/JBC)**
 75/JBC2 Prussian Landwehr Lancer 1815 £6.25



75/JBC2



CS24



CS25

NEW next month. The first of a superb 75mm range depicting regiments of the British Army, each from a glorious page of their history. Designed by Charles C. Stadden, these figures must be seen to be believed.

Also next month a completely new 54mm gun kit and limber. Plus artillery teams and scenic effects for System 12, plus more 25mm cavalry standard bearers.



HINCHLIFFE MODELS LTD.

MELTHAM, HUDDERSFIELD, ENGLAND HD7 3NX

April 1976 additions to range

25mm

English Civil War (ECW)

- ECW20 Musketeer, marching
- ECW21 Pikeman, marching
- ECW22 Pikeman, at ease
- ECW23 Musketeer, loading

English Civil War Cavalry (ECWC)

- ECWC13 Carabinier, at rest
- ECWC14 Heavy cavalry, firing pistol
- ECWC15 Medium cavalry, with pistol

Ancient Roman (AR)

- AR28 Roman Legionary, charging
- AR29 Roman Legionary, charging with sword
- AR30 Centurion, charging

Ancient Greek (AG)

- AG13 Hoplite 400 B.C., at rest
- AG14 Light Pelast
- AG15 Iphicratean Hoplite
- AG16 Hypaspist

American War of Independence (AW)

- AW23 Continental Infantry in hunting shirt, marching
- AW45 British Infantryman campaign dress, charging

American War of Independence Cavalry (AWC)

Horse and rider cast as one

- AWC8 Baylor's Dragoon Trumpeter

Equipment Groups (EG)

- EG13 English Civil War Mortar waggon, 4 oxen and driver **£1.44**

75/JBC3



25mm RE3 Polish Infantryman with musket and poleaxe (HUNGARIAN STYLE)

75/JB6



75mm Julian Benassi Range (75/JB)

- 75/JB6 Officer of the Sardinian Infantry Regiment Savoyen 1803-14. **£2.50**
- 75/JBC3 French Cuirassier trooper 1815 **£6.83**

System 12 Artillery Packs (STAP)

- STAP3 British Napoleonic Artillery horse team (1) Y
- STAP4 French Napoleonic Artillery horse team (1) Y

Equipment

- STG3 British Napoleonic Limber (2) Y
- STG7 French Napoleonic Limber (2) Y

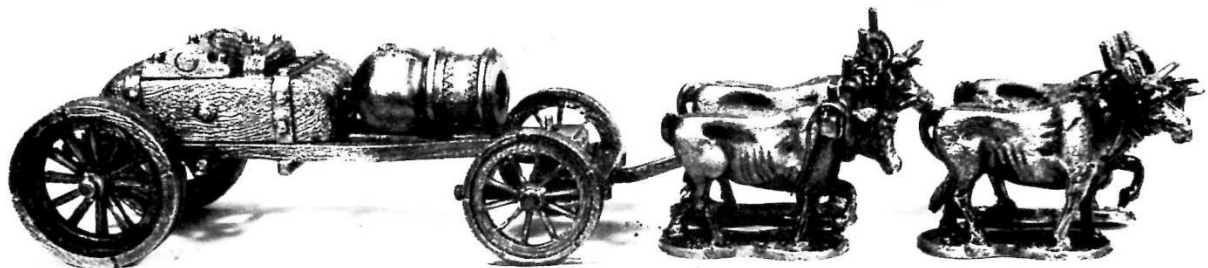

EG13 Note: Mortar 25/AR is not included



HINCHLIFFE MODELS LTD.

MELTHAM, HUDDERSFIELD, ENGLAND HD7 3NX

LOOK NO FURTHER THAN THE HINCHLIFFE COLLECTION

May 76

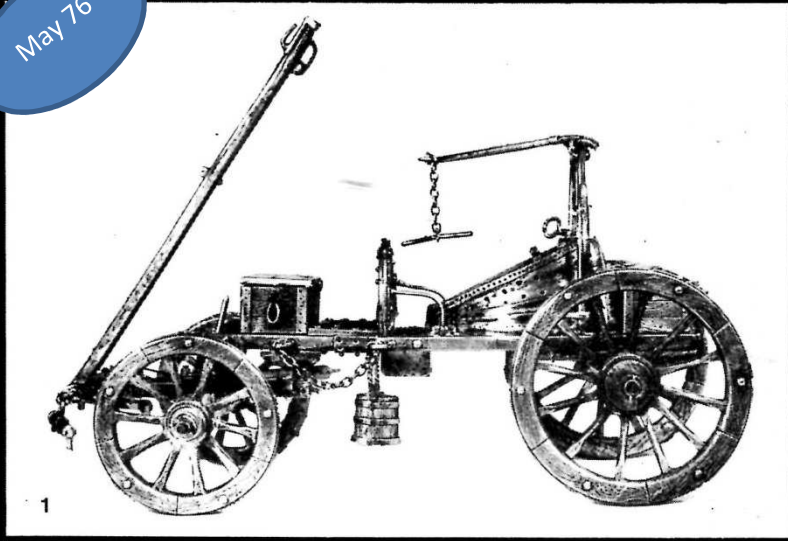

1



5



2



3

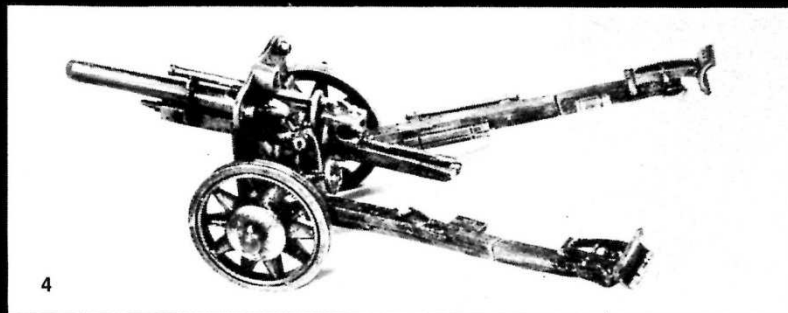

4

MAY ADDITIONS TO RANGE

EG11 Egyptian Line Chariot £1.08

EG14 Egyptian Pharaohs Chariot (incl. Royal Standard Bearer) £1.21

EG15 Hittite Chariot £1.08

ILLUSTRATIONS

1. ME/W/3 54mm French Napoleonic Forge de Campagne

2. CS23 54mm Serving girl with tray

3. AWC5 25mm British Light Dragoon, firing carbine

4. 20/22 20mm German W.W.II 10.5cm light Field Howitzer L.28

5. 75/JBC3 French Cuirassier 1815

HINCHLIFFE MEANS QUALITY

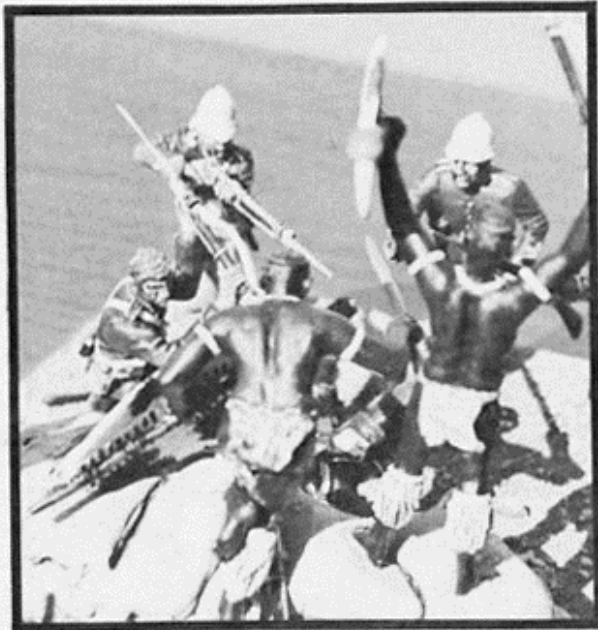

54 MM ZULU RANGE BY CLIFF SANDERSON
 BUILD AN ACTION DIORAMA WITH TWO FIGURES OR FORTY
 TWENTY DIFFERENT FIGURES AND DIORAMA PACKS

In Campaigns
 1976

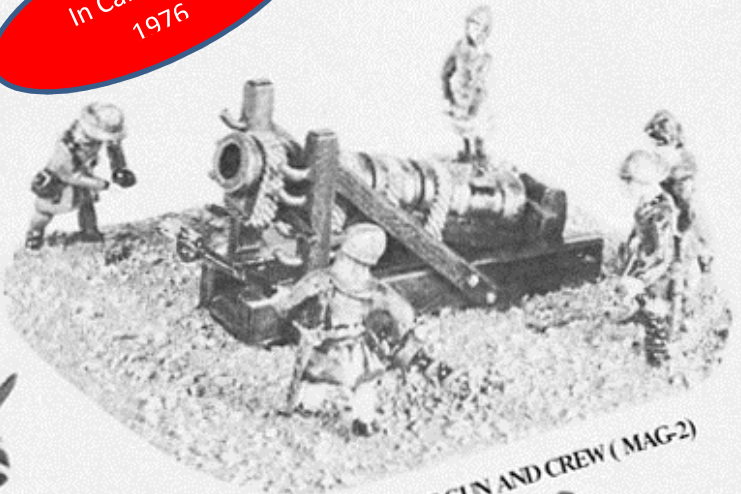

25 MM SEIGE GUN AND CREW (MAG-2)

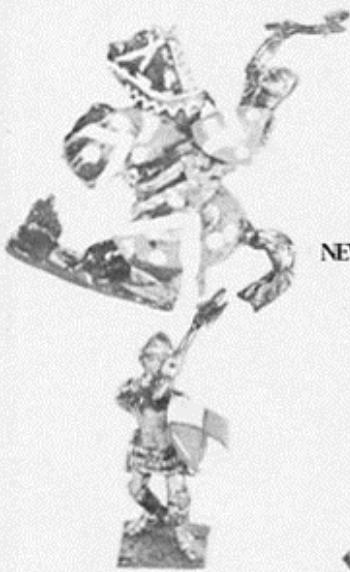

NEW!! AGINCOURT MEDIEVALS AND RENAISSANCE LANSKNECHTS



NOW AT YOUR LOCAL DEALER: NEW RELEASES IN MEDIEVALS, RENAISSANCE LANSKNECHTS,
 RUSSIAN NAPOLEONIC ARTILLERY, PRUSSIAN LANDWEHR, AND MANY NEW FANTASY FANTASTICS, AND THE
 ALL NEW EDGAR RICE BURROUGHS MARTIAN RANGE AND RULES

Manufactured By:

HERITAGE MODELS, INC.
 2916 BLYSTONE LANE
 DALLAS, TEXAS 75220
 (214) 351-3708

Complete Listing \$.50
 NEW! Fully Illustrated
 Hinchliffe Catalogue and
 Handbook \$3.95

ORDER DIRECT OR FROM ONE OF OUR FINE DISTRIBUTORS:

COULTER-BENNETT LTD.
 12158 HAMLIN ST.
 NORTH HOLLYWOOD, CA. 91606

MILITARY MODEL DISTRIBUTORS
 3461 EAST TEN MILE ROAD
 WARREN, MI. 48091

DELAWARE VALLEY HOBBY DIST.
 701 ASHLAND
 FOLCROFT, PA. 19023

WE DON'T MAKE THE MOST.....WE MAKE THE BEST



HINCHLIFFE MODELS LTD.

MELTHAM, HUDDERSFIELD, ENGLAND HD7 3NX

JUNE 1976 ADDITIONS TO RANGE

Ancient Egyptian (AE)

- AE13 Sherden
- AE14 Hittite Axeman
- AE15 Hittite Guardsman
- AE16 Hittite Spearman

Medieval (MF)

- MF8 English man-at-arms 1415
- MF9 English Archer 1415
- MF10 English Knight with sword and shield 1415
- MF11 English Knight with battleaxe 1415
- MF12 French peasant with spear 1415
- MF13 French peasant with bow 1415
- MF14 French crossbowman 1415
- MF15 French Knight with sword and shield 1415

Medieval Cavalry (MC)

- MC8 French mounted men-at-arms 1415

Medieval Horses (MH)

- MH7 Heavy horse walking

Equipment Groups (EG)

- EG16 Medieval Tumbril with wattle sides and 2 oxen and peasant driver — **£1.00**

Julian Benassi Range (75/JB)

- 75/JB10 Austrian Carpenter of Artillery 1808-12 —
- 75/JB11 Austro-Hungarian Grenadier 1814 —

£2.50
£2.50

(As Illustrated)

See your retailer today or write direct. Current price list 12p



75/JB10



HINCHLIFFE MODELS LTD.

MELTHAM, HUDDERSFIELD, ENGLAND HD7 3NX

July 1976 additions to range

25mm

Medieval Foot (MF)

- MF16 Artilleryman
- MF17 Artilleryman, firing gun
- MF18 Artilleryman, with rammer
- MF19 Burgundian hand gunner
- MF20 Peasant levy 1300-1400
- MF21 Spearman 1300-1400
- MF22 Two artillerymen carrying seige gun breech (for 25AY) — 20p

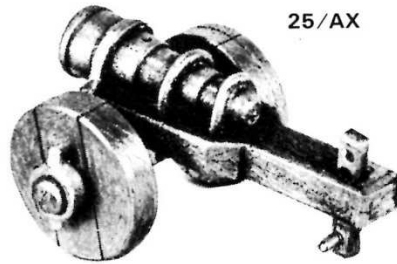

25/AX

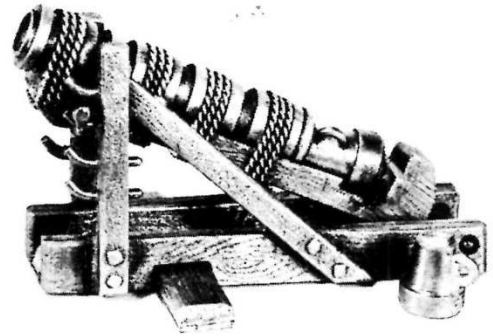

25/AY

Medieval Cavalry (MC)

- MC9 English knight with sword and shield 1415 (MF10)
- MC10 English knight with battle axe 1415 (MF11)
- MC11 English knight with lance 1415
- MC12 French knight with sword and shield 1415 (MF15)
- MC13 French knight with lance

(The code in brackets is the equivalent figure on foot)

Renaissance (RE)

- RE23 Landsknechts Pikeman
- RE24 Landsknechts Officer
- RE25 Landsknechts Arquebusier
- RE26 Landsknechts Halberdier
- RE27 Landsknechts Drummer
- RE28 Landsknecht with double handed sword

Medieval Horses (MH)

- MH8 Rearing knights charger

25mm Equipment (25/)

- 25/AX Early Medieval wheeled Bombard 50p
- 25/AY Early Medieval Seige Gun on base £1.00

75mm

Julian Benassi Range (75/)

- 75/JB8 French Infantryman 1914 £2.50
- 75/JB9, Adjutant — Chef Chasseur /Alpin 1915 £2.50

Our manufacturers in the USA.: Heritage Models Inc., 2916 Blystone Lane, Dallas, Texas 75220

We recommend

HUMBROL AUTHENTIC MILITARY COLOURS

for all our products

SEND 65p for a catalogue or SAE for listing



Added a distribution line

NEW 54's from



OLD GUARD

The latest Old Guard figures are now available. For the Empire Builder, there are soldiers from Imperial Germany and Great Britain; for the Ancients enthusiast, a dismounted Roman Auxiliary cavalryman and for the modern collector, a Wehrmacht ski-trooper in steel helmet. If you hanker for civilian figures, then look closely at our two new Personality models. With their distinctive high quality and scrupulous detail in design and casting, Old Guard figures are for the collector who prefers something better.

- H18 British Officer, East Africa, 1914
- H19 African Askari, British Forces, East Africa, 1914
- H20 German Officer, Schutztruppen, East Africa, 1914
- H21 German Askari, East Africa, 1914
- H22 German Garde Uhlan NCO, mounted, 1912 2.99
- P5 Sherlock Holmes
- P6 Doctor Watson
- M44a Wehrmacht ski-trooper, walking, 1944
- M95a Roman Auxiliary cavalryman, dismounted 1.40
- M95b Roman cavalry horse, standing 1.60

Figures H18 to H21, P5, P6 M44a and M95a are priced at £1.40 plus vat. H22 costs £2.99 plus vat and M95b is £1.60 plus vat. From your local dealer or by direct mail order.

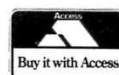
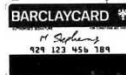

Telephone: Rothbury (066 92) 246



HINCHLIFFE MODELS LTD

21 STATION STREET · MELTHAM · HUDDERSFIELD HD7 3NX

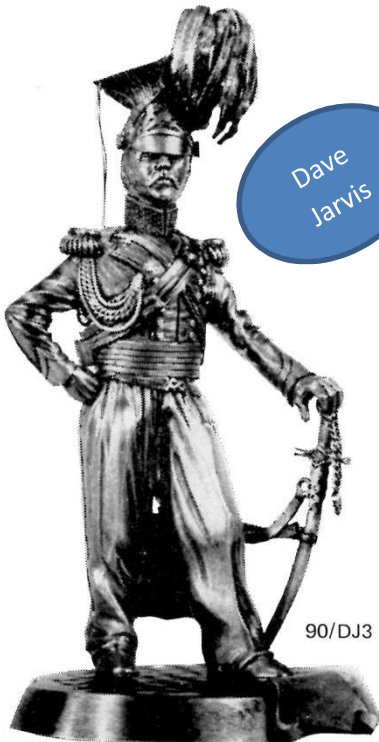

Dave
Jarvis

90/DJ3

FABULOUS NEW 90mm RANGE

We're wrong again!

Sorry, we thought we had already brought you the ultimate in design but just look at this first attempt; we illustrate it on the left.

Note the designer's name, Dave Jarvis, he's going straight to the top of the league. A successful silversmith working from his own premises in Hatton Garden, Dave is going to enrich this hobby for all time. If you like it write and tell us; we will be delighted, so will Dave and perhaps you'll give us a hint of what you would like to see produced for your own particular collection — this man is not only talented, he's versatile.

Watch for our illustrated advert next month, don't rely on reviewers, they're way behind this Company.

Available now in 90mm scale

90/DJ2	Tirailleur Grenadier, Young Guard, 1809	£3.50
90/DJ3	Officer, 9th Lancers, circa 1820	£4.50

Ready next month—90/DJ1 Highlander and then a fabulous R.H.A. Troop Captain from the Peninsular, just a little tribute to Norman Ramsey.

4M INTRODUCING FOREMOST 4M

A complete new range of miniatures!! We are privileged to produce this fabulous new line of wargame figures and accessories on a contractual "limited run" basis only.

These must be the ultimate and are strictly for the connoisseur at lower than wargame prices.

Available from our Company direct mail only — see the separate illustrated advertisement next month. 25mm for September and October with a good sprinkling of 15mm for the festive season. Separate lists available — send S.A.E. and ask for FOREMOST.

You all know the designer, he sprung it on us, so we're springing it on you!

First offerings include The Imperial Guard at Waterloo; can't be bad!

If it's all too much for you, just don't read the rest of these pages. Just refuse to be involved with the finest bunch of enthusiasts in the world — not everyone is ready for it!

AUGUST 1976 ADDITIONS TO RANGE

Russian Napoleonic (RN)	25mm Equipment (25/)
RN22 Musketeer in greatcoat and shako, advancing	25/AK Russian 6 pdr. cannon — 54p
RN23 Musketeer Officer in greatcoat and shako, advancing	25/AL Russian Limber — 54p
RN24 Horse Artilleryman with rammer	25/AZ Russian 10 pdr. licorne (Howitzer) — 54p
RN25 Horse Artilleryman manning gun	25/BA American War of Independence 3 pdr. Galloper gun — 54p
RN26 Horse Artilleryman holding round	Equipment Groups (EG)
RN27 Horse Artilleryman sighting gun	EG17 3 pdr. galloper gun with draught horse, out-rider and attendant. £1.00
RN28 Horse Artillery Officer	90mm
RN29 Moscow Militia with pike	Jarvis Range (90/J)
RN30 Moscow Militia with musket	90/DJ2 Tirailleur Grenadier, Young Guard 1809
Russian Napoleonic Cavalry (RNC)	90/DJ3 Officer, 9th Lancers, circa 1820
RNC12 Uhlan	
RNC13 Uhlan Officer	

WHAT'S IN THE PIPELINE?

Well, we've mentioned Ramsey and Foremost 25's and 15's and we've got the 54mm Ambulance set out of our system! What about the German W.W.II 150mm Field Gun? At the moment it's filling our benches, it's big in 54mm scale—so it just adds up to a lot of super detail.

Oh! Yes! And a fabulous portrait figure of Beau Nash from yet another new designer — it's all too much for us, what with all this hot weather and the issue of the world's first 25mm Russian Artillery System!

It could all be eclipsed by the latest offering to come out next month — the best from Benassi yet — a mounted Chasseur a Cheval of the Guard — a speciality primarily for the boss but we're making it available so you can all share in it!

Dave Jarvis 90mm (painting Mirof 70ies)



"Said a famous reviewer to us one day,
How can I my true thoughts of you say?
Yours are the best, the whole world knows
But what of me would say your foes!"

So what! If we can't hit the reviews we will
just have to do our own in the finest
Catalogue/ Handbook ever brought to the
hobby.

The Hinchliffe collection, its all in the new

**HINCHLIFFE HANDBOOK
FOR WARGAMERS AND
COLLECTORS**

— over 130 pages — over 500 specific
figure colour instructions — over 900
superb drawings and photographs. Many,
many articles and hints and tips.

We never do things by half! If you're not
"clutching" one of these at Northern
Militaire, you're just nobody in the hobby.

Out at the end of August £2.00 at your
retailer or £2.15 direct from the factory.

Sep 76

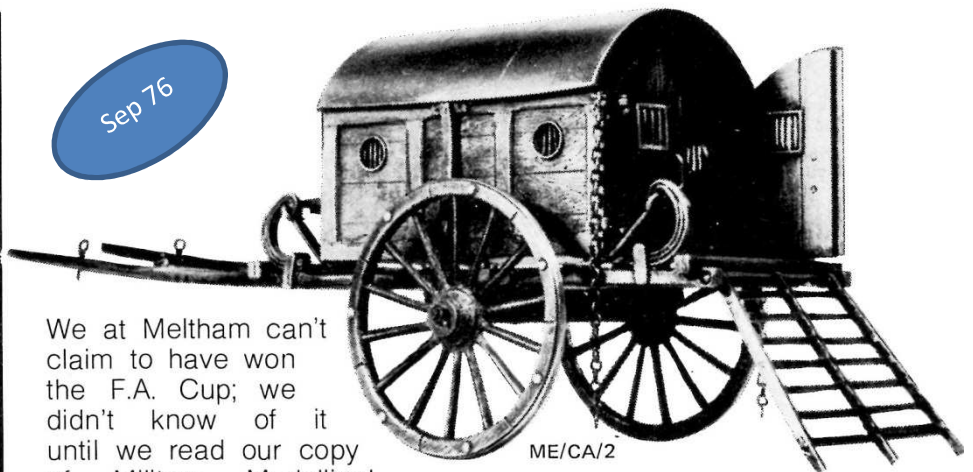

We at Meltham can't
claim to have won
the F.A. Cup; we
didn't know of it
until we read our copy
of Military Modelling!

ME/CA/2

We were much too busy producing for you this superb 54mm French Napoleonic Larrey Light Ambulance set. It's complete with a two horse team and mounted driver of train and one on foot. We had to do the attendants — because it's so lifelike that those horses would have taken off!!

Out for the end of September, Surgeons, etc., to follow.



HINCHLIFFE MODELS LTD.

MELTHAM, HUDDERSFIELD, ENGLAND HD7 3NX

Nov 76



PN1

REVENGE JENA!

Refight with Blucher the campaigns of 1813. Throw the French from Prussian soil. Your chance to create the Prussian National Armies of 1813 and the Waterloo period, with a superb range of 25mm collector/ wargame figures.

Prussian Napoleonic (PN)

- PN 1 Line infantry, advancing
- PN 2 Line Infantry, charging
- PN 3 N.C.O., with colours
- PN 4 Line Infantry, Officer, charging
- PN 5 Line Drummer
- PN 6 Line Grenadier, attacking
- PN 7 Line Grenadier, Officer, attacking
- PN 8 Guard Infantry, charging
- PN 9 Guard Infantry, Officer
- PN11 Line Jaeger, standing, firing
- PN14 Landwehr Infantry, advancing
- PN16 Landwehr Drummer
- PN17 Landwehr Officer
- PN18 Gunner, quenching sponge
- PN19 Gunner, carrying round
- PN20 Gunner, pulling on wheel spokes

- PN21 Gunner, with portfire and linstock
- PN22 Gunner, Officer

Prussian Napoleonic Cavalry (PNC)

- PNC 1 Line Dragoon, at rest position, H2, H6
- PNC 2 Uhlán, LH2, LH4, LH5
- PNC 3 Line Dragoon, Officer, at rest, H2, H6
- PNC 4 Line Dragoon, Trumpeter at rest, H2, H6
- PNC 5 Uhlán Officer, LH2, LH4, LH5
- PNC 6 Line Cuirassier, charging, H4, H5
- PNC 7 Uhlán Trumpeter, LH2, LH4, LH5
- PNC 8 Line Cuirassier, Officer, charging, H4, H5
- PNC 9 Line Cuirassier, Trumpeter, H4, H5
- PNC10 Guard Hussar Trooper LH3, LH4, LH6
- PNC11 Guard Hussar Officer LH3, LH4, LH6

- PNC13 Landwehr Trooper LH3, LH4, LH6
- PNC14 Landwehr Officer LH3, LH4, LH6

25mm Prussian Equipment

- 25/AF Prussian 6pdr. gun
- 25/AG Prussian 12pdr. gun
- 25/AH Prussian 7pdr. Howitzer
- 25/AJ Prussian Napoleonic Limber
- 25mm Prussian Personality Figure
- PF7 Field Marshal — Prince Blucher

New Releases

- PN10 Reserve Infantry Advancing
- PN12 Reserve Infantry Officer
- PN13 Landwehr Charging
- PN15 Landwehr Officer Charging
- PN23 Horse Gunner with Round
- PN24 Horse Gunner with Rammer
- PN25 Horse Gunner Manning Gun
- PN26 Horse Gunner with Portfire

THE HINCHLIFFE HANDBOOK — "HIGHLY RECOMMENDED"

Packed full of ideas, hints, painting instructions etc. — plus over 900 separate drawings and photographs. £2.00 from your retailer or £2.20 direct.

TWO FABULOUS NEW RELEASES

Both fine detailed and fine cast. From two talented designers.

See them at your local stockists or write direct to HINCHLIFFE MODELS for a fine service on all your orders.



75/JBC5
French Napoleonic Scout
Lancer (Eclaireur) 2nd Regt. 1813
£6.83



90/DJ4
R.H.A. Troop Artillery Captain.
Peninsular/Waterloo period.
£4.50



HINCHLIFFE MODELS LTD.

MELTHAM, HUDDERSFIELD, ENGLAND HD7 3NX

Jan 77

NEW 25mm LATE BYZANTINES!

Probably one of the most successful of the later ancient wargame armies. Yet another superb new addition to the Hinchliffe Range. Followed next month by another completely new and exciting Ancient wargame range.

Late Byzantine (BA)

- BA1 Super heavy infantry
- BA2 Heavy infantry
- BA3 Peltast
- BA4 Varangian Guardsman
- BA5 Light infantry staff sling
- BA6 Light infantry archer
- BA7 Light infantry crossbowman
- BA8 Light infantry javelinman

Late Byzantine Cavalry (BAC)

- BAC1 Kataphractoi lancer
- BAC2 Kataphractoi archer
- BAC3 Avar irregular light Cavalry
- BAC4 Kibanophori
- BAC5 Turk irregular cavalry
- BAC6 Thematic heavy cavalry lancer
- BAC7 Thematic heavy cavalry archer
- BAC8 Norman auxilliary
- BAC9 Pecheneg irregular Cavalry

Ancient Horses (AH)

- AH15 Byzantine armoured horse
- AH16 Byzantine heavy horse

30 YEARS WAR

Swedish Trumpeter Circa 1640



75/JB14
ONLY £2.50

Whatever your taste in Military Modelling come to stands 96 & 97 at the Model Engineering Exhibition.

We've got it all in every scale, can't claim constant, because we claim realism – long men, short men, fat men and thin men all brought to realistic life – come along again and talk to us it's our life blood!

Next month – new 90mm Jarvis figure – Officer 33rd 1815.

Mar 77

GERMAN 150mm W.W.II FIELD HOWITZER SFH18

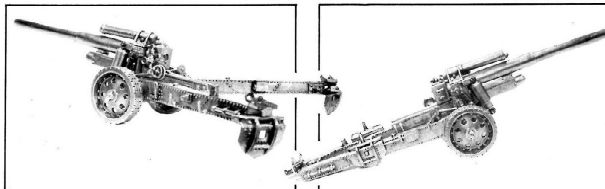
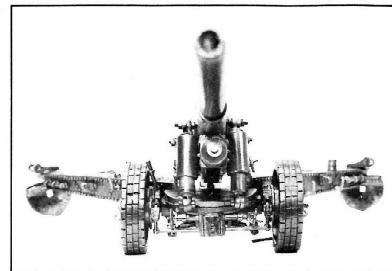
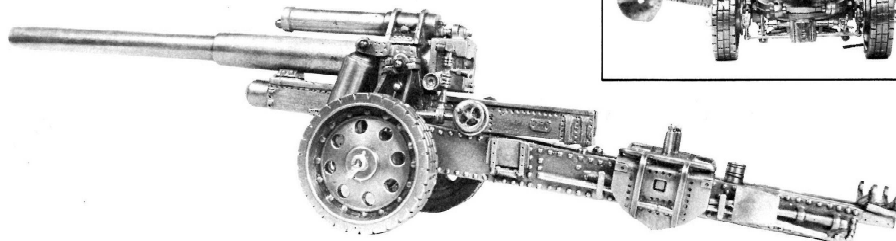

Model Code ME/G/21 £8.50
Another superb model in the Hinchliffe Range
Scale 1/32nd 54mm (Suitable for a 1/35th Collection).
70 part kit – easy to assemble – Full instruction and painting
booklet. See it at your retailer's or write direct to



HINCHLIFFE MODELS LTD.
STATION STREET, MELTHAM, HUDDERSFIELD
YORKS

May 77



Russian Napoleonic Dragoon. N.C.O
1812 75/JB 12 £2.73

Russian Bashkir with horse. 1812-14 75/JBC 7 £9.50

An unusual subject, the Bashkirs were irregular cavalry, often armed only with bows and arrows, some even wearing mail coats and ancient helmets. This figure portrays one of Napoleon's antagonists very much as he could have been in the 1814 occupation of Paris after campaigning across Europe collecting a various assortment of weapons and accoutrements on the way, plus a French horse to boot!



keep your collection up-to-date with **HINCHLIFFE**

"What the Experts Say About Us –

- every figure in the range, cavalryman or infantryman is of a uniformly high quality.
- highly distinctive and extremely likely to make all Napoleonic wargamers hate the sight of their existing army.
- it has long been my feeling that some manufacturers tend to scale down the size of their horses and this applies to all scales not just wargames figures, but the Hinchliffe heavy cavalry mounts are 100% correct.
- whoever designed them deserves a medal because they breathe life from every inch of their highly decorative and most detailed figures.
- perhaps the best action miniatures I have seen for some time, the photograph does scant justice to the finished articles."

*CHARLES GRANT AND DONALD FEATHERSTONE
WARGAMERS NEWSLETTER AND MILITARY MODELLING*

**160 New Releases this month
and all available – wonder at
the expertise**

COMING SOON!

More superb 25mm and 15mm Releases. New ranges of Fantasy figures. The Red Baron in 75mm. A 90mm Royal Scots Greys Trooper. A new 54mm Artillery piece. A great new 54mm Colonial range. 54mm action cavalrymen. New 54mm galloping gun teams. More 25mm equipment pieces etc. etc. etc.

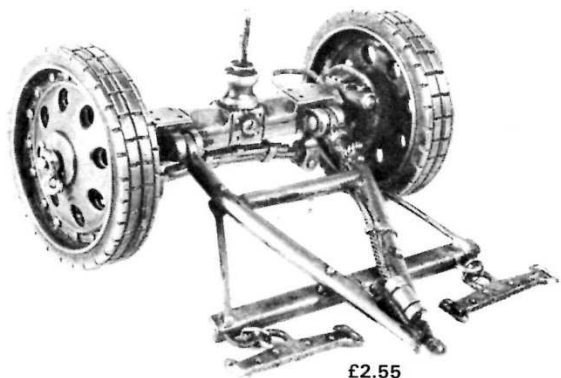

£2.55

ME/L/5 German WW11 Heavy Gun Limber
(For use with ME/G/21 German WW11 150mm Field Howitzer)



HINCHLIFFE MODELS LTD.
MELTHAM, HUDDERSFIELD, ENGLAND HD7 3NX

Jul 77

TEN NEW AUSTRIAN FIGURES

to swell your existing army. Plus the usual remakes with which we quietly improve our range each month.

Top service to the Wargamers from leaders in the hobby – a feast for the Diorama men as usual.

JUNE ADDITIONS TO RANGE

25mm

Bavarian Napoleonic (BVN)

BVN3 Line Infantry Standard bearer

Austrian Napoleonic (AN)

- AN13 Artilleryman with rammer
- AN14 Artilleryman manning gun
- AN15 Artilleryman carrying round
- AN16 Artilleryman with portfire
- AN17 Artillery Officer
- AN18 Landwehr drummer
- AN19 Landwehr Standard Bearer



Austrian Napoleonic Cavalry (ANC)

- ANC10 Dragoon trumpeter
- ANC11 Dragoon Standard Bearer
- ANC12 Hussar trumpeter

75mm

Julian Benassi Range (75/JB)

75/JB16 Baron Von Richtofen – £3.07

(as illustrated)

Jul 77



54/JB1



54/JB3

54/JB8



54/JB6



54/JB7



54/JB9



54/JB2

SUDAN

We gave you the Zulu War range and now we follow it with the beginning of yet another winner. More to follow! We've heard about the Camel Corps, the Gatlings and the Naval boys, the 15 pdr. guns and Gardiners — no promises but, like you, we would like to see it complete.

SUDAN RANGE

54mm

- 54/JB1 British Line Infantry Officer
- 54/JB2 British Line Infantryman, dragging forward ammunition box
- 54/JB3 British Line Infantryman, withdrawing bayonet
- 54/JB4 British Line Infantryman, parrying with rifle across body
- 54/JB5 British Line Infantryman, lying wounded
- 54/JB6 Dervish tribesman, attacking with spear and shield
- 54/JB7 Dervish tribesman, attacking with sword and shield
- 54/JB8 Dervish tribesman, falling wounded
- 54/JB9 Dervish tribesman, standing with sword and shield
- 54/JB10 Dervish tribesman, lying wounded — with standard

Each figure in easy to assemble kit form — complete colouring and historical notes included

£1.81 per figure

— at your retailers now or direct from Hinchliffe Models Ltd.

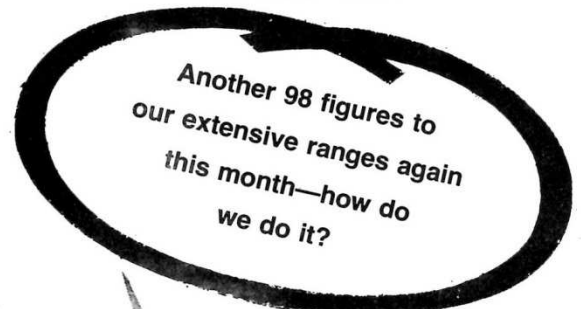

m your retailer or £2.20 direct. Price list 12p.

**AUTHENTIC
MILITARY COLOURS**

for all our products



HINCHLIFFE MODELS LTD.

MELTHAM, HUDDERSFIELD, ENGLAND HD7 3NX

COMING NEXT MONTH

Sep 77

In 25mm

Landsknecht Wagon (Big!) with lots of extras in the way of baggage and camp followers. American Civil War and Renaissance guns. Renaissance and English Civil War carts and wagons. New chariots and more new figures.

In 54mm

New figures and vignettes.

In 75mm

Another new figure. An extravaganza for the month following and one to top that for the month after.

AUGUST ADDITIONS TO RANGE

25mm Once piece casting (OPC)

OPC 9 Austrian Infantry Colonel

OPC 10 Prussian Infantry Colonel

Austrian Napoleonic (AN)

ANC 13 Uhlan Standard Bearer

ANC 14 Uhlan trumpeter

ANC 15 Cuirassier Standard Bearer

Prussian Napoleonic (PN)

PN 27 Landwehr Standard Bearer

PN 28 Reserve Infantry Standard Bearer

PN 29 Reserve Infantry drummer

PN 30 Fusilier standing firing

Prussian Napoleonic Cavalry (PNC)

PNC 15 Prussian Hussar trumpeter

PNC 16 Prussian Hussar Standard bearer

PNC 17 Prussian Dragoon Standard Bearer

PNC 18 Prussian Cuirassier Standard bearer

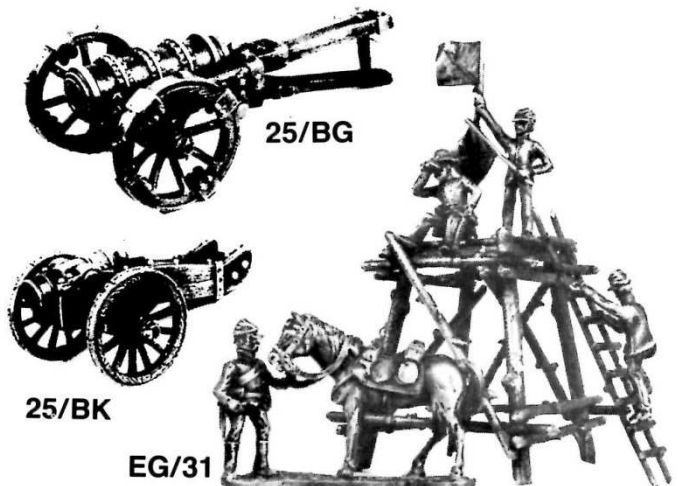
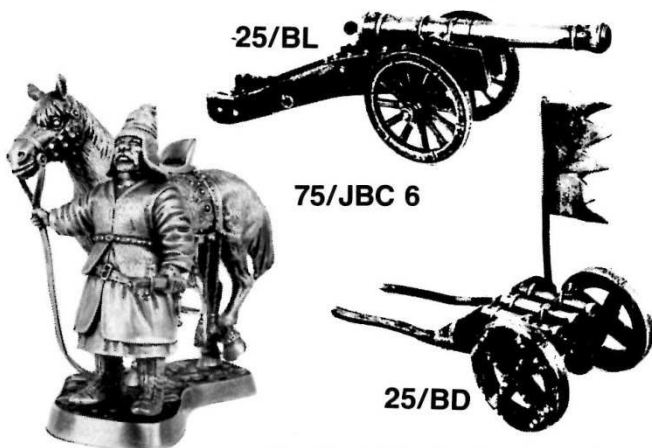

Equipment (25/)

25/BB Archers stakes (3 sets of 3 per pack) **35p**

25/BC Renaissance triple organ gun **60p**

25/BD Late Medieval/Renaissance 3 barrelled cannon **60p**

25/BG Late Medieval/Renaissance Heavy field/Siege gun **£1.65**

25/BH Pack of large barrels and lids (barrel height 25mm) 2/pack **35p**

25/BK 18th Century Heavy Howitzer **70p**

25/BL 18th Century Heavy field/siege gun **70p**

25/BM Pack of medium barrels and lids (barrel height 18mm) 4/pack **35p**

Equipment Groups (EG)

EG22 English Civil War Horse Drawn Wagon with two powder barrels, 1 driver, gunner attendant sat on barrels and marker flag. **£1.20**

EG23 English Civil War hand drawn cart with 2 powder barrels, 2 men pulling cart, 1 gunner in attendance and marker flag **70p**

EG31 American Civil War Signal tower with 2 signallers, 1 officer, 1 horse and holder. Approx. height of tower 55mm. **£2.10**

EG41 Wine and Water cart - all periods, with horse and attendant. **£1.20**

75mm Benassi Range (75/JBC)

75/JBC 6 Mongul Warrior/Herdsman and pony **£7.67**

HINCHLIFFE GUIDE TO WARGAMING

- a new booklet available now **£1.10** +15p postage and packing
- a 'Step by Step' guide, the only booklet to really explain it to the rank beginner.
- plenty of diagrams and illustrations, plus lots of hints and tips on painting and making your own terrain features.
- This booklet breaks off where the 'hard to follow' other books begin!

The Hinchliffe Handbook £2.00 from your retailer or £2.20 direct. Price List 12p.



HINCHLIFFE MODELS LTD.

MELTHAM, HUDDERSFIELD, ENGLAND HD7 3NX

Oct 77



75/JB18

SEPTEMBER, 1977 ADDITIONS TO RANGE

25mm Equipment (25/)

- 25/BE Renaissance Single Bank Organ gun - 60p
- 25/BF Renaissance Falconet Cannon - 60p
- 25/BY American Civil War Parrot Gun 20 pdr. - 60p
- 25/BO Hand hewn timber trestle bridge comprising - 1 centre trestle, 2 road sections, 2 end ramps and all necessary stanchions and hand rails - Approx. length 270mm - height 40mm - width 70mm. - £5.50
- 25/BP Trestle bridge addition kit. Each kit adds approx. 135mm in length to bridge 25/BO. Contents - 1 centre trestle, 1 road section and all necessary stanchions and hand rails. - £2.10
- 25/BV American Civil War Gatling gun - 60p

Equipment Groups (EG)

- EG19 Landsknecht Baggage Wagon, with separate loading of camp equipment, 4 horse team including mounted driver, camp followers, and children, company shoe carrier, donkey and load, loaded wheel barrow and attendant. - £5.50
- EG20 Renaissance horse drawn wagon with 2 mortars, powder barrel, 1 driver and 2 gunner attendants, plus marker flag. - £1.20
- EG24 English Civil War hand drawn cart with 2 powder barrels, 2 men pulling and 1 gunner attendant, plus marker flag. - 70p
- EG26 Renaissance hand drawn cart with powder barrel, marker flag, 2 men pulling, 1 gunner in attendance. - 70p
- EG34 Roman Tusedo or tortoise comprising of 12 men and roof of shields. - £1.65
- EG39 Light Chinese Chariot and crew. - £1.20
- EG40 Selucid Barbarian 4 horse chariot and crew - £1.65

54mm Vignettes (54/V)

- 54/V5 Medieval Bombard and 2 gunners - £3.07

75mm Julian Benassi Range (75/JB)

- 75/JB18 Irish Army Motor reserve Officer 1911 - £3.07



54/V5



25/BF



EG/19

ALL WE ADVERTISE IS AVAILABLE
 Note: Foremost Range now available retail
 The Hinchliffe Handbook £2.00 from your retailer
 or £2.20 direct. Price list 12p



HINCHLIFFE MODELS LTD.

MELTHAM, HUDDERSFIELD, ENGLAND HD7 3NX

NOVEMBER RELEASES

FIRST EQUIPMENT FOR 75mm COLLECTORS

75mm Equipment (75/)

75/A Early field piece 1580-1650 - £12.00

75/B Heavy gun limber (suitable for 75/A) - £5.00

NEXT IN SERIES

French Napoleonic 8 pdr and 12 pdr guns

Equipment (25/)

25/CC Dowel sided baggage wagon - all periods - £1.20

25/CE Small catapult with sling. Roman to
Medieval - £0.70

Equipment Groups (EG)

EG30 British Napoleonic Coehorn Mortar Party. 4 men carrying mortar, 1 officer, gunner with rammer and bucket, gunner carrying powder barrel, donkey with shot load. - £1.20

EG33 Light Renaissance baggage wagon, shields arranged on top cover, driver on seat, two horses in tandem - £1.65

EG44 Horse drawn two wheeled powder cart. 16th - 19th century - £1.20

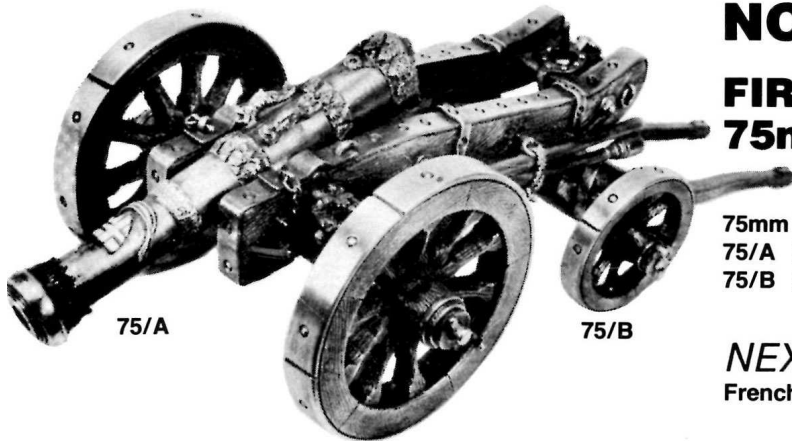

25mm

One Piece Casting (OPC)

OPC 6 French Line Infantry Colonel

OPC19 British Hussars trooper

OPC20 British Hussars Officer

OPC21 British Hussars trumpeter

OPC22 British Hussars standard bearer

OPC23 American Civil War Union Colonel

OPC24 American Civil War Confederate Colonel

FIRST OF A NEW 80mm SERIES

PLANNED EDITIONS EACH MONTH

80mm Figures (80/)

80/1 American Civil War Zouave Sergeant 14th New York

80/2 Wounded Confederate soldier

£4.50

EACH

WATCH OUR COLUMNS
FOR EXCITING NEW RELEASES

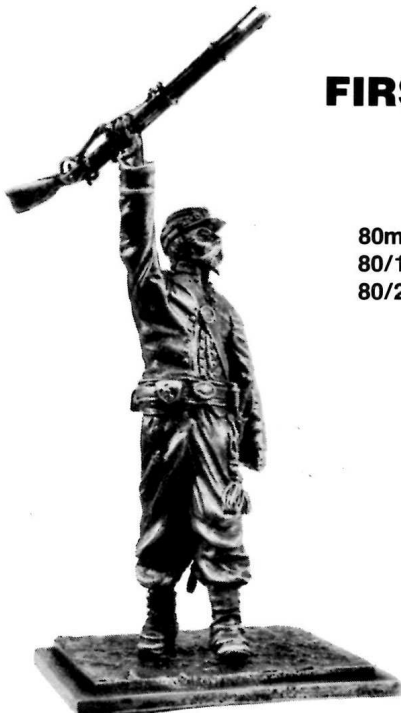



HINCHLIFFE MODELS LTD

21 STATION STREET · MELTHAM · HUDDERSFIELD HD7 3NX

JANUARY, 1978 RELEASES



We've been spreading the hobby around for a long time – now we're taking it up to new heights! What wargamer or collector can stand against our siege equipment – can you?

25mm Equipment (25/)

25/BT Ancient/Medieval storming tower £8.20
(approximate height 180 mm.)

25/BU Storming tower skin cladding kit £2.45

25/BT

Include now
Heritage

HERITAGE 15mm NAPOLEONICS

PRUSSIAN NAPOLEONIC INFANTRY (65p Blue)

- 15/187 Jaegers firing
- 15/188 Line or reserve infantry charging
- 15/189 Line or reserve infantry defending
- 15/190 Grenadiers attacking (plumed)
- 15/191 Reserve Infantry charging (Stovepipe shako)

PRUSSIAN NAPOLEONIC CAVALRY (65p Blue)

- 15/198 Uhlans (wearing shapska)
- 15/199 Landwehr Lancers (Stovepipe shako)
- 15/200 Dragoons
- 15/201 Cuirassiers

PRUSSIAN NAPOLEONIC COMMAND PACK (32p Green)

- 15/CP31 Line Infantry command
- 15/CP32 Guard or Grenadier command
- 15/CP35 Jaeger command
- 15/CP37 Uhlans (wearing shapska) command
- 15/CP38 Landwehr Lancers (Stovepipe shako)
command
- 15/CP39 Dragoon command
- 15/CP40 Cuirassier command

PRUSSIAN NAPOLEONIC ARTILLERY AND EQUIPMENT (65p Blue)

- 15/AP20 Foot Artillery crew
- 15/AP21 Horse Artillery crew
- 15/AP23 6 pdr. gun
- 15/AP24 7 pdr. Howitzer
- 15/AP25 12 pdr. gun

Jan 78

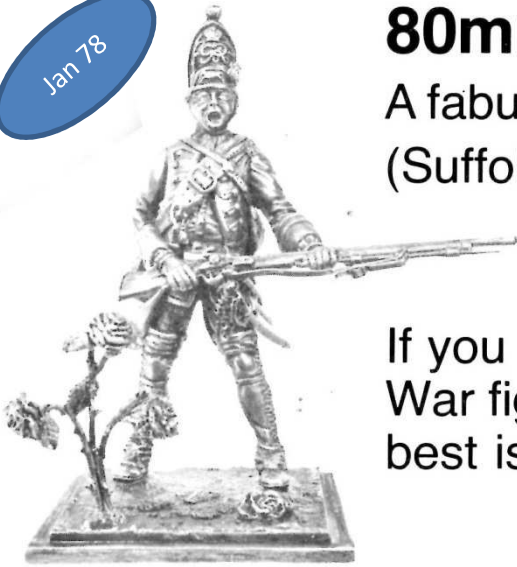

80mm figure "THE MINDEN CRY"

A fabulous new release of a grenadier 12th Foot (Suffolk Regt.) 1759. Model Code 8003 only £4.50.

If you haven't seen the last two American Civil War figures released Nov. 1977 — Do! and the best is yet to come.

LABAYEN

Now distributor of Labaven

We are proud to announce our appointment as sole U.K. distributors of Labaven 54mm military figures. These exquisite figures portray to the full the style and mood of their period. The Napoleonic have to be seen to be believed. Elegance and authenticity go hand in hand to make these pieces a collectors dream.

All models supplied fully assembled — unprimed.

Figures and lists can be obtained either direct or from your retailer.



General Chonard Catalogue No. 19

All U.K. trade Enquiries welcomed.



Napoleon Catalogue No. 2



Lancer Trooper 1812 Catalogue No. 23C



Chasseur-a-Cheval 1806 Catalogue No. 24C



Marine Officer Full Dress 1811 Catalogue No. 29F

Foot figures £2.50 each

Cavalry figures £7.48 each



Some Labaven



HINCHLIFFE MODELS LTD.

MELTHAM, HUDDERSFIELD, ENGLAND HD7 3NX

FEBRUARY 1978 ADDITIONS TO RANGE

80mm

A good follow-up to the superb figure we introduced last month of the Grenadier of the Suffolk Regiment at Minden 1759.

This one by the same designer of an Officer of the Cameron Highlanders Tel-el-Kebir 1882 continues to set the pattern of this new range of the British Army through the ages.

NEXT TO COME — A Trooper of the Parachute Regiment at Arnhem 1944



CODE 8004
£4.50

HERITAGE 15mm PRUSSIAN NAPOLEONICS

This month's releases complete your Prussian Army!

(Only Guard Jaegers and Hussars to release)

NEXT MONTH — The first half of a superb Austrian Army.

Infantry (65p blue) (12 per pack)
15/192 Reserve infantry charging
15/193 Landwehr infantry attacking
15/194 Landwehr infantry defending
15/195 Guard marching (use as Guards, Grenadiers or Fusiliers)

Infantry Command Pack (32 green) (6 per pack)
15/CP34 Landwehr command

Artillery Pack (65p blue)
15/AP22 Horse team
(4 horses, limber and riders)

Cavalry (65p blue) (8 horse & riders)
15/202 Landwehr lancers (wearing shako)
15/203 Landwehr lancers (wearing schirmutze)

15/204 Landwehr lancers (wearing shako with cover)

Cavalry Command Pack (32p green) (4 horse & riders)

15/CP41 Landwehr lancer (wearing shako) command

15/CP42 Landwehr lancer (wearing schirmutze) command

15/CP43 Landwehr lancer (wearing shako with cover) command

15/CP44 Blucher and staff

15/CP45 Marshal and staff

Superior 15mm Figures — Top quality — Top design

Ask your retailer for details or write direct.

25mm February additions — YET MORE STANDARD BEARERS AND TRUMPETERS!

Prussian Napoleonic (PN)
PN31 Guard Infantry standard bearer
PN32 Guard Infantry drummer

Prussian Napoleonic Cavalry (PNC)
PNC19 Uhlan standard bearer
PNC20 Landwehr trumpeter
PNC21 Landwehr standard bearer

Brunswick Napoleonic (BRN)
BRNC7 Uhlan standard bearer
BRNC8 Hussar standard bearer

Austrian Napoleonic (AN)
AN7 Grenadier standard bearer

Napoleonic Peninsular (NPC)
NPC17 Spanish Lancer standard bearer

American Civil War (ACW)
ACW34 Confederate Officer charging

Ancient Hun (AHU)
AHUC3 Noble heavy cavalry

One Piece Castings (OPC)
OPC6 French Line infantry colonel
OPC8 American Civil War Dismounted trooper in kepi, holding horse.

25mm Equipment (25/)
25/CG Gun mantlet Renaissance/Medieval — 41p

80mm
8004 Officer of the Cameron Highlanders Tel-el-Kebir 1882 — £4.50



HINCHLIFFE MODELS LTD.

MELTHAM, HUDDERSFIELD, ENGLAND HD7 3NX

MANUFACTURERS OF FINE CAST MODELS

LICENSED MANUFACTURERS OF: HERITAGE U.S.A. DER KRIEGSPIELER U.S.A. BUGLE & GUIDON U.S.A.

VALIANT U.S.A.. SOLE IMPORTERS LABAYEN.

Jul 78

Valiant Miniatures 54mm and 90mm Collectors Figures

stardate:3000

Warfare on the Milky Way.

The bitter struggle between the outnumbered forces of the United Planetary Federation and those of the Alien Star Empire began with the Alien invasion of Federation territory in SD 3021-7 and has lasted eight long years. No end is yet in sight. Many inter-Galactic ships are now available. Send S.A.E. for list.

FIGHTING SAIL 1:2000

Sailing ship battles of the Napoleonic era can only be brought to real life using these highly detailed cast ships and sails. Together with full painting and rigging instructions.

All lists now available please send S.A.E.



9732 French Line Infantryman 1813

LABAYEN

Lancer Trooper 1812
Cat. No. 23C.

These exquisite 54mm Collectors figures are still available either direct from ourselves or your nearest retailer. If you haven't seen any of these figures then hurry while these prices hold.

£2.50 Foot

£7.48 Mounted

Send S.A.E. for list.



DER KRIEGSPIELER FANTASY FIGURES OF LORE AND LEGEND

(£1.40 per pack)

1476 1404 1477 1478 1453 1478

1504

Red Goblins
1404 Great Goblins with Maces & Whips (6)
1405 Great Goblins with short swords and Bills (6)
1406 Great Goblins command (4)

Easterners
1438 Men of Ruin with bows and spears

Special Personality Set
1475 Evil Riders (3)

Gobbles and Boogers
1453 Tasmanian Devil (3)

1476 Amazons (6)
1477 Skeleton men (6)
1478 Pixies (8)

Men of Goodyly Nature
1486 Hillmen of Lame (6)
1488 Spearmen of Ringo (6)
1490 Rangers with bows and spears (6)
1494 Rangers of the North (3)

Allies of Goodyly Men
1504 White Horsemen with Lances Mounted (3)

Send S.A.E. for full list.

You'll be amazed at the number of 25mm figures we've remodelled in the last 12 months. Send a S.A.E. for full list and sample.

HERITAGE 15mm

AUSTRIAN NAPOLEONIC:

- 15/211 Landwehr defending.
- 15/214 Elite Infantry Hungarian Grenadier charging.
- 15/208 Hungarian Fusiliers charging.
- 15/213 Elite Infantry German Grenadiers defending.
- 15/209 Hungarian Fusiliers attacking.
- 15/210 Hungarian Fusiliers defending.
- 15/215 Tyrolean Jaegers firing.

Command Packs

- 15/CP46 German Fusilier command pack.
- 15/CP47 Hungarian Fusilier command pack.

- 15/CP48 German Grenadier command pack.
- 15/CP49 Hungarian Grenadier command pack.

Prussian Napoleonic

- 15/196 Guard Jaegers.
- 15/187 Hussars.

Command Pack

- 15/CP33 Guard Jaeger command.
- 15/CP36 Hussar command pack.
- 15/CP41 Landwehr Lancer command wearing shako (now available).

NEXT MONTH: W.W.II 15mm tanks, armoured cars, etc. 15mm Napoleonic Russians. 25mm Fantasy to mention only a few.

The Hinchliffe Handbook £2.50 from your retailer, £2.80 direct. Price list 20p plus 9p p&rp.

Our manufacturer in the U.S.A. — Heritage Models Inc., 9840 Munro Drive, Building 106, Dallas, Texas.



The perfect base... The perfect finish...

- White Primer - Matt Varnish
- Specially formulated for use on metal - plastic - wood.
- 6oz. can
- 50p from your retailer + 10p postage and packaging direct.

Full stocks now available.



Bugle & Guidon

Vaillant





HINCHLIFFE MODELS LTD.

MELTHAM, HUDDERSFIELD, ENGLAND HD7 3NX

MANUFACTURERS OF FINE CAST MODELS

LICENSED MANUFACTURERS OF: HERITAGE U.S.A. DER KRIEGSPIELER U.S.A. BUGLE & GUIDON U.S.A. VALIANT U.S.A.. SOLE IMPORTERS LABAYEN.

AUG 78

DER KRIEGSPIELER FANTASY FIGURES OF LORE AND LEGEND

- 1409 White Goblins with short sword and spears (6)
- 1411 Wild wolves with axes, whips and spears (6)
- 1422 Evil men half breeds (8)
- 1436 Khan command (4)
- 1512 Flying Gargoyles with spears and swords (4)



HERITAGE FANTASY

- 1345 Goblins with spear and shield (8)
- 1350 Umberhulk (3)
- 1351 Minotaur (3)
- £1.40 Full list available Per Pack

NEW! FRENCH DRAGOON TROOPER 1815

This figure will be released next month as a vignette together with a cantiniere.



ONLY
£8.95
75/JBC9

Valiant Miniatures

54mm and 90mm Collectors Figures

FIGHTING SAIL 1:2000 Scale

Ship of the line rules available £5.80

stardate:3000

Warfare on the Milky Way. Full list available.

COMING NEXT MONTH:

- 75mm French Cantiniere
- 80mm Corporal 1st Kings
- Royal Dragoons Waterloo Period



OPC45 7 Years War Hussar Trooper

MORE 15mm, MORE FANTASY AND A NEW 25mm SEVEN YEARS WAR RELEASE AND

Anytime now a release of the Horse Figure of the Year — it's all complete, we're only fighting for room in our spate of new items.

HAVE YOU TRIED OUR FIRST CLASS DIRECT MAIL ORDER SERVICE?

Let the whole of the Hinchliffe range be available to you anywhere in the country — 10% postal charge under £5 Orders above £5 *Post Free*. Write today.

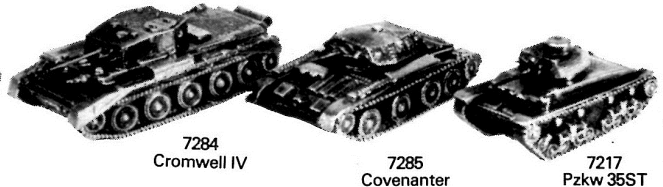

7284 Cromwell IV

7285 Covenantor

7217 Pzkw 35ST

Available Now! 15mm W.W.II Figures and Equipment
Send S.A.E. for List.

BOOK November 4th & 5th in your Diary **NORTHERN MILITAIRE '78**

Bigger and brighter than ever with news of our new National Competition and a chance to meet and talk with the top designers in the hobby — **Our Designers!**

REMEMBER! WE ARE THE ONLY COMPANY THAT DOES IT ALL from Super 90s down to the smallest winged pixie — **over 450** new releases this year alone — more than 3 per working day. Be someone in the hobby — at least own our new up-to-date list *20p plus 9p p&p*.

HINCHLIFFE HANDBOOK **£2.50** plus 30p p&p. GUIDE TO WARGAMING **£1.10**

Our manufacturer in the U.S.A. — *Heritage Models Inc., 9840 Munro Drive, Building 106, Dallas, Texas.*



HINCHLIFFE MODELS LTD.

MELTHAM, HUDDERSFIELD, ENGLAND HD7 3NX

MANUFACTURERS OF FINE CAST MODELS
LICENSED MANUFACTURERS OF: HERITAGE U.S.A. DER KRIEGSPIELER U.S.A. BUGLE & GUIDON U.S.A.
VALIANT U.S.A., SOLE IMPORTERS LABAYEN.

AUGUST RELEASES 1978 The beginning of a new IN DEPTH range of great new figures.

A Seven Years War Range

primarily at the request of our continental neighbours but available to you now. Foot figures, cavalry, guns and wagons, the usual coverage you have come to expect along with our continuing policy of adding to our existing ranges.



SYAC2

25mm Seven Years War Austrian Infantry (SYAI)

- SYA1 German musketeer advancing
- SYA2 German grenadier advancing
- SYA3 German officer waving hat
- SYA4 German standard bearer
- SYA5 German musketeer drummer
- SYA6 German grenadier drummer
- SYA13 Grenze infantry advancing
- SYA14 Grenze infantry officer
- SYA15 Grenze infantry firing

- SYA16 Jaeger firing
- SYA21 German infantry officer advancing

Austrian Cavalry (SYAC)

- SYAC1 Cuirassier trooper
- SYAC2 Cuirassier or carabinier officer
- SYAC3 Cuirassier standard bearer
- *OPC48 Cuirassier or carabinier trumpeter
- SYAC4 Carabinier trooper
- *OPC44 German mounted infantry officer
- *OPC One piece casting



OPC45
Hussar Trooper
(not yet available)



SYAC1



SYAC4



OPC44

DON'T FORGET!
MANY REMADE 25mm NAPOLEONICS
NOW AVAILABLE.

75mm CANTINIÈRE 75/JB21

Sorry about promising this lady as a vignette with the dragoon 75/JBC9 in last months advertisement. We'll try to bring them together for next month.

No sorry's for this one — it's another and at a super price for value. We've a stable full just waiting for issue so don't be frightened of starting that collection.

Prussian Dragoon 1815
Model Code 75/JBC10 **£8.95**

DON'T FORGET
VALIANT MINIATURES — LABAYEN
— FOREMOST —
(LISTS AVAILABLE)
OUR ON THE PREMISES RETAIL SHOP



NEW

NEW RELEASE

80mm CORPORAL 1st ROYAL DRAGOONS

WATERLOO PERIOD



Model Code 8006

£4.50

25mm Heritage Fantasy

- 1336 Elves with bow and sword (6)
- 1361 Elves with spear, sword and shield (6)
- 1345 Goblins with spear and shield (8)
- 1337 Great Goblins with spear and shield (8)

NEW RELEASES
FIGURES OF
LORE AND LEGEND
MORE NEXT MONTH

Der Kriegspieler Fantasy

- Dwarves of strong visage
- 1458 Dwarves marching with mattocks (8)
- Trolls of Evil Disposition
- 1419 Cave Trolls (6)
- Mountain Goblins
- 1415 Goblins with axes and spears (8)



HINCHLIFFE MODELS LTD.

MELTHAM, HUDDERSFIELD, ENGLAND HD7 3NX

MANUFACTURERS OF FINE CAST MODELS

LICENSED MANUFACTURERS OF: HERITAGE U.S.A. DER KRIEGSPIELER U.S.A. BUGLE & GUIDON U.S.A. VALIANT U.S.A., SOLE IMPORTERS LABAYEN.

Nov 78



13th CENTURY MOUNTED KNIGHT 80mm SCALE

NEW

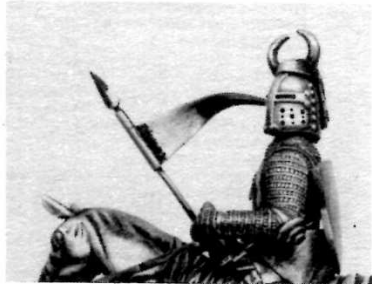

Another 80mm masterpiece from the skilled hands of sculptor Paul Knight.

This figure is specially sculptured to give scope to the painting of an infinite variety of heraldic designs some of which are described in the colour guide and instruction leaflet.

A variety of helmets, shields, hands, etc. are included in the kit to alter for great variations of assembly, a few are shown in the inset illustrations.

Next on the list from this fabulous designer a full action 80mm mounted 17th Lancer lifted straight from the Light Brigade Charge!



25mm PRUSSIAN 7 YEARS WAR

NEW RELEASES

OCTOBER ADDITIONS TO RANGE

PRUSSIAN INFANTRY

- SYP1 Musketeer Advancing
- SYP2 Fusilier Advancing
- SYP3 Grenadier March Attack
- SYP4 Infantry Officer
- SYP5 Musketeer Drummer
- SYP6 Fusilier Drummer
- SYP7 Grenadier Drummer
- SYP8 Fusilier Standard Bearer
- SYP9 Musketeer Standard Bearer
- SYP10 Jaeger Firing
- SYP11 Von Kliest Infantry Man
- SYP12 Von Kliest Infantry Drummer
- SYP13 Von Kliest Officer

PRUSSIAN CAVALRY

- SYPC1 Cuirassier Trooper H2
- SYPC2 Cuirassier Officer H2
- SYPC3 Cuirassier Trumpeter H2
- SYPC4 Cuirassier Standard Bearer H2

MODEL CODE 8007

£18.00

TAKE NOTE!

VALIANT - FANTASY - 15MM - LABAYEN & HINCHLIFFE

Next 75mm cavalry figure from the talented hands of Julian Benass - A mounted Carabinier trumpeter to fit with your 1815 range.

Why not visit our fully stocked 'on the premises' retail shop. Over 1,000 painted models on display. Open six days per week - Weekdays 9 a.m. to 4.30 p.m. Saturday 10 a.m. - 12.30 p.m. and 2.00 p.m. - 4.00 p.m.

AND DON'T FORGET OUR FIRST CLASS DIRECT MAIL ORDER SERVICE.

Don't forget Northern Militaire, come along and meet our design team - there's a lot of them about! Even the governor does his little bit in and among.

PRICE RISE ON ITS WAY - OF ALL OUR RANGES

Jan 79

IT'S CHRISTMAS AT HINCHLIFFE

BUYING A PRESENT? SPENDING CHRISTMAS MONEY PERHAPS? TAKE A GOOD LOOK AT US AND ALLOW US TO SPOIL YOU FOR CHOICE

OVER 2,000 MODELS IN STOCK
AND AVAILABLE EITHER FROM YOUR RETAILER OR DIRECT FROM US

15mm Napoleonic and WWII figures and equipment. Realistic figures — accurately detailed.
25mm What period interests you? Napoleonic — British Colonial — American Civil War — American War of Independence — Ancients — Medieval — Renaissance — Science Fiction — Fantasy —
PLUS EQUIPMENT IN ALL PERIODS.
54mm Collectors figures, guns, limbers, horses and equipment. Masterpieces at reasonable prices.



75/C2
75mm
Assyrian
Horse
Archer

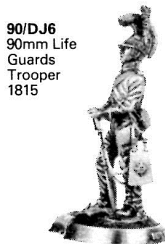

90/DJ6
90mm Life
Guards
Trooper
1815

8007 80mm
Mounted
Knight



9801
54mm
"Valiant"
Wyatt
Earp

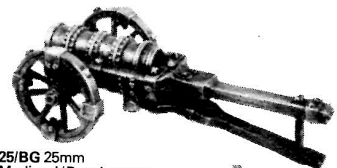

25/BG 25mm
Medieval/Renaissance
siege gun



75/JBC4
French
Napoleonic
Chasseur à
Cheval of
the Guard
1814

75mm Foot and cavalry figures through the ages — Plains Indians — Assyrians — Napoleonic — Medieval — WWI — WWII. Designed by top designers and superbly produced by Hinchliffe.

80mm A range of seven figures, all very different, from Napoleonic, Medieval and WWII periods.

90mm A beautifully sculptured range by Dave Jarvis — expertly produced and cast by Hinchliffe.

Not forgetting we carry ranges of Valiant — Heritage — Der Kriegspieler — Labayen — All included in our 20p price list plus 9p postage.



7285 15mm Covenanter tank

We're on our way to Wembley.



MODEL ENGINEER EXHIBITION 4th-13th JANUARY 1979 NEW ITEMS?

Come and chat to our designers and staff.
See you there!

Full range for sale — Plus a few surprises.

STAND 108 IN THE GREENWICH ROOM.



HINCHLIFFE MODELS LTD.

MELTHAM, HUDDERSFIELD, ENGLAND HD7 3NX

MANUFACTURERS OF FINE CAST MODELS

LICENSED MANUFACTURERS OF: HERITAGE U.S.A. DER KRIEGSPIELER U.S.A. BUGLE & GUIDON U.S.A. VALIANT U.S.A., SOLE IMPORTERS LABAYEN.



HINCHLIFFE MODELS LTD.

MELTHAM, HUDDERSFIELD, ENGLAND HD7 3NX

MANUFACTURERS OF FINE CAST MODELS

LICENSED MANUFACTURERS OF: HERITAGE U.S.A. DER KRIEGSPIELER U.S.A. BUGLE & GUIDON U.S.A. VALIANT U.S.A.. SOLE IMPORTERS LABAYEN.

Feb 79

Only one new release this month but a few reminders of some of our 'Golden Oldies'.

We're busy at the moment building up to the launch of two new business ventures which should excite some of the more discerning amongst you and we've also other plans for the New Year.

Our own *New Fantasy* pieces, star ships, star ships, men-o-war and the usual steady and some would say remorseless additions to our model soldier ranges.

— We love model soldiers — they may be more demanding in design, they may even get less than profitable, but its in the blood and some may even say it shows — they did in the U.S.A. last October when they awarded us the top award for the best historical range at Origins 78 very gratifying for us and you.

75mm BENASSI CAVALRY

- 75/JBC1 Spanish Mounted Trooper 7th Cavalry (Lancier de la Mancha) 1813
- 75/JBC2 Prussian Landwehr Lancer 1815
- 75/JBC3 French Cuirassier Trooper 1815
- 75/JBC4 French Napoleonic Chasseur A Cheval of the Guard 1805-14
- 75/JBC5 French Napoleonic Scout lancer (Eclaireur) 2nd Regiment 1813
- 75/JBC6 Mongul Warrior/Herdsman & Pony
- 75/JBC7 Russian Bashkir with horse 1812-14
- 75/JBC8 French Napoleonic Mounted Gendarme (Army of Spain 1810)
- 75/JBC9 French Dragoon Trooper 1815
- 75/JBC10 Prussian Dragoon 1815



75/JCB4

£9.85 each

90mm

90mm. Figures (90)

- 90/1 Prussian Grenadier 1812
- 90/2 Prussian Landwehr Infantry 1814
- 90/3 Cleve-Bung Infantry Officer 1812

90mm. Jarvis Range (90/DJ)

- 90/DJ1 Highland Private 42nd Regt. Waterloo
- 90/DJ2 Young Guard Traillleur, Grenadier 1809
- 90/DJ3 Officer, 9th, Lancers, Circa 1820
- 90/DJ4 R.H.A. Troop Artillery Captain Peninsular/Waterloo Period
- 90/DJ5 Officer of the Light Company 33rd Regt. of Foot (West Riding 1815)
- 90/DJ6 Life Guards Trooper 1815
- 90/DJ7 British Officer 7th Hussar 1808



90/DJ7

£6.30 each



8007

80mm

80mm Figures (80/)

- 8001 American Civil War Zouave Sergeant 14th New York
- 8002 Wounded Confederate Soldier
- 8003 Grenadier 12th Foot (Suffolk Regt.) 1759
- 8004 Officer of the Cameron Highlanders Tel-El-Kebir 1882
- 8005 Parachute Regt. Private Arnhem 1944
- 8006 Corporal 1st Royal Dragoons Waterloo Period
- 8007 Medieval Mounted Knight £18.00

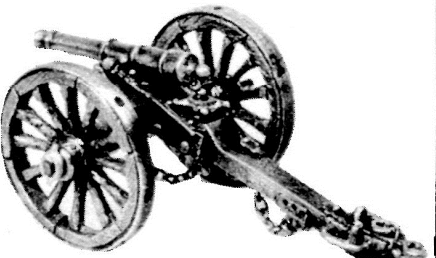

WARGAMERS

Its 1979 for our design of 15mm figures, they will be different to all that have marched before be sure of that but in keeping with our usual style they'll be better than anything you've ever seen — impossible! It's been said before but we just seem to manage it somehow — not a lot for starters but a little bit of the best!!
Watch the ads.



HANDBOOK £2.75 plus 30p post & packing. GUIDE TO WARGAMING £1.10 plus 20p postage & packing.



HINCHLIFFE MODELS LTD.

MELTHAM, HUDDERSFIELD, ENGLAND HD7 3NX

MANUFACTURERS OF FINE CAST MODELS
LICENSED MANUFACTURERS OF: HERITAGE U.S.A. DER KRIEGSPIELER U.S.A. BUGLE & GUIDON U.S.A.
VALIANT U.S.A.. SOLE IMPORTERS LABAYEN.

ANNOUNCE BIG CHANGES IN 1979 TO SPREAD THE HOBBY
LOOK OUT FOR **CALDER CRAFT** A range of exciting new and updated Hinchcliffe products spreading like wildfire through the retail toy and model shops.

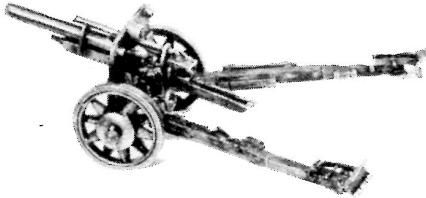

Mar 79
Apr 79

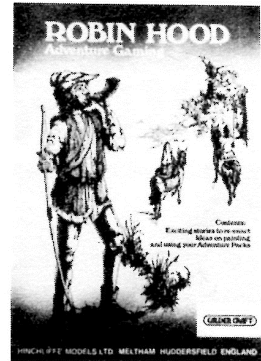

***SKIN PACKED**
1/72 scale (20mm) WWII equipment — and new figure groups complementary to all 1/72 scale plastic model kit manufacturers ranges.

***BLISTER PACKED**
25mm figures and equipment — British, French, Prussian and Russian Napoleonic. PLUS Medieval, Robin Hood and Fantasy figures. This range together with superb explanatory booklets to introduce new people to wargaming and adventure gaming.

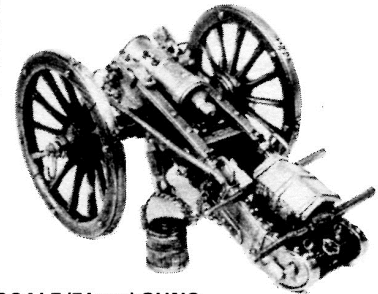
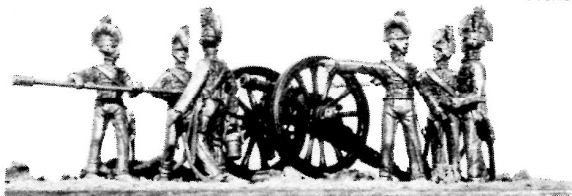

***30mm DIORAMA PACKS**
Collectors sets in new full colour boxes.



***1/32 SCALE (54mm) GUNS**
A range of 6 popular guns beautifully boxed with all parts skin wrapped for ease of assembly.

***1/32 SCALE (54mm)**
Artillery crews gun & horse teams: A magnificent range of diorama kits including specially made bases with simulated wood edging and a new German WW2 horse gun team on a cobbled Warsaw street.



***SAMURAI WARRIOR**
Totally remade and skin packed for ease of assembly. A masterpiece for collectors and painters.



***ROBIN HOOD BOARD GAME**
The first board game for military enthusiasts with painted 25mm figures

CALDER CRAFT

is available exclusively through the retail trade. Send to us for a free price list enclosing an S.A.E. and see your local retailer for further details.

WHAT ABOUT THE HINCHLIFFE RANGE?

Hinchcliffe Models will continue to lead the specialist wargame market and large figure collector market with new releases monthly. All Hinchcliffe Model lines are available directly from us or through your local specialist military model retailer. 15mm, 25mm, 54mm single figures (except artillery crews), 75mm, 80mm and 90mm ranges over 1,500 different lines are available in the Hinchcliffe range. However all items in the Calder Craft series have been dropped from the Hinchcliffe range. Send TODAY for a NEW LIST — price 20p + 9p p&p.

Introduce Caldercraft

HINCHLIFFE 7 YEARS WAR: THE RANGE IS NOW COMPLETE (25mm) to build your new army | **HOBBY SPRAYS: NEW DELIVERY — MASSES OF STOCK. ORDER NOW TO SAVE DISAPPOINTMENT LATER — ONLY 70p incl VAT.**



HINCHLIFFE MODELS LTD.

JOIN THE PROFESSIONALS!

HANDBOOK £2.75 plus 30p post & packing. GUIDE TO WARGAMING £1.10 plus 20p postage & packing.

Jun 79

CALDER CRAFT®

THE NEW NAME FOR MILITARY MODELLING

Son of Hinchliffe Models, Calder Craft presents a compact range of military modelling and wargaming figures and equipment from 1/72 scale to 1/32 scale, all authentically reproduced. The quality and craftsmanship is amongst the highest available in the world today. These magnificent diorama kits, shown complete with base, are perfect in every detail like the featured German WWII gun team horses and crew, the first of its kind ever to be offered to collectors, or, the French Napoleonic Larrey Light Ambulance, realistically portrayed with horses and attendants... these are just a few models from the exciting new Calder Craft collection which ranges from 1/72 scale WWII figures and equipment, designed to complement plastic model kits, through to the amazing Japanese Warrior Commander, acclaimed as the finest Samurai Warrior ever to be produced.

1/32

HORSE TEAMS AND ARTILLERY Dioramas compatible to 1/35 scale



Model 5406
German World War II Gun Team Horses
and Crew RRP £47.00

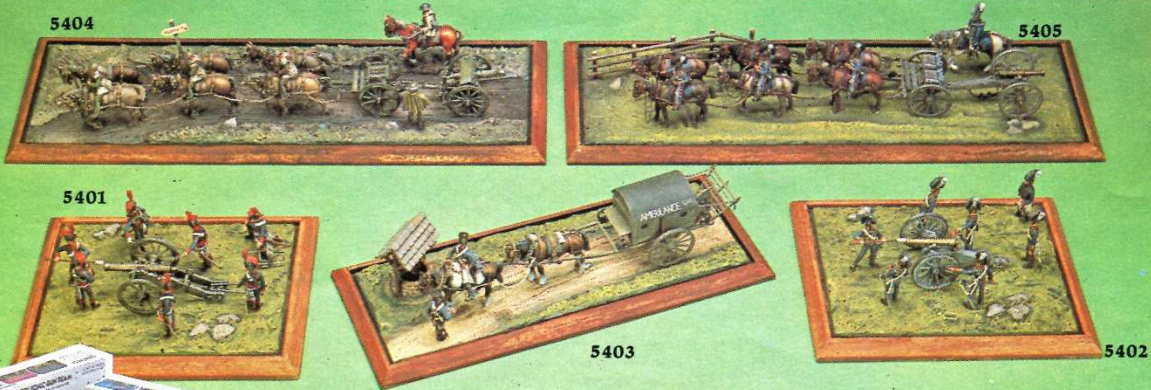

Model 5404 British World War I Gun Team Horses and Crew RRP £33.00
Model 5405 British Napoleonic Gun Team Horses and Crew RRP £33.00
Model 5401 8 pounder gun and crew French Horse Artillery of the Guard 1815 RRP £11.50
Model 5403 French Napoleonic Larrey Light Ambulance, Horses and Attendants RRP £18.50
Model 5402 6 pounder Gun and Crew of the British Napoleonic Horse Artillery 1815 RRP £11.50
So, if you're into modelling, get into Calder Craft – the new name in Military Modelling – for beginners and experts alike.
Available through all leading model shops – send for FREE Leaflet to:
CALDER CRAFT, A DIVISION OF HINCHLIFFE MODELS, MELTHAM, HUDDERSFIELD, HD7 3NX, ENGLAND.

Some Caldercraft 30mm



MODEL CODE 3001

A GROUP OF OFFICERS, NCO'S AND PRIVATES OF THE SPANISH ARMY 1812 ROUND A CAMP FIRE ROASTING AN OX.



MODEL CODE 3004

8 POUNDER GUN AND CREW FRENCH NAPOLEONIC HORSE ARTILLERY OF THE GUARD.

75/JB22



75/JB23



HINCHLIFFE MODELS LTD.



21 STATION STREET,
MELTHAM, HUDDERSFIELD HD7 3NX

June 79

Benassi unsurpassed
more releases from this talented designer all at the usual price of £4.00 in your shop now or write direct. More releases next month including the promised gun team — Just no room left this month!

- 75/JB22 English or French Captain — E.C.W. Period
- 75/JB23 Hand Gunner — Early Renaissance Period
- 75/JB24 Landsknecht Pikeman Mid XVI Century
- 75/JB25 Guard Cossack Officer in Greatcoat 1812

75/JB24



75/JB25



Jul 79

75mm EARLY GUN TEAM 1580-1650

AVAILABLE AS SEPARATE ITEMS



- 75/JB28 Peasant woman with flagon £4.00
 - 75/JBC14 Mounted gunner/driver 1580/1650 £9.85
 - 75/JBC15 Harnessed horse (for between shafts) £6.50
 - 75/A Early field piece 1580-1650 £13.20
 - 75/B Heavy gun limber £5.50
- (Chains, links, rope traces, etc., are packed with 75/JBC15)

75/JB28

75/JBC14

75/JBC15

75/A

MORE 54mm SUDAN RANGE NEXT MONTH

MORE 75's NEXT MONTH

COLLECTORS U.S.A. COLLECTORS

We will shortly begin our own manufactory in the U.S.A. Bringing to you the quality, service, enthusiasm and knowledge that U.K. collectors have long enjoyed. Our full range of products will not be immediately available but rapid expansion is planned. The address to contact:

9468 Folkstone Road, Dallas, Texas 75220

See our wargames advertisement in this issue for details of our main London stockist—in depth for in depth collectors and gamers.

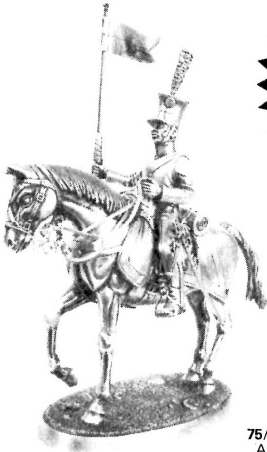

75/JBC12 Trooper 9th Cheveau-Légers Lanciers 1811
Another new superb mounted for your Napoleonic collection



75/JBC13

75/JBC13 Mounted infantry officer—Boer War period
75/JBC26 Royal Scots Fusilier Sergeant 1895

75/JBC26

A doughty pair to round off this page of 75's—be quick to add them to your shelves, keep ahead for there's more to come!



HINCHLIFFE MODELS LTD.

21 STATION STREET, MELTHAM, HUDDERSFIELD HD7 3NX, ENGLAND.

Sole Australian & New Zealand Agent: **Paul Fordyce**, Battlefield, 50 Clissold Parade, Campsie, N.S.W. 2194 Australia.

KINDLY MENTION 'MILITARY MODELS' WHEN REPLYING TO ADVERTISEMENTS



HINCHLIFFE MODELS LTD.

MELTHAM, HUDDERSFIELD, ENGLAND HD7 3NX

NEW 25M/M RELEASES

Sep 79

We have now completed our Foremost list. 115 items of above average, specially designed and marketed to give that 'something special' feel to your best units and to bring a sprinkle of life to your wargame table.

Prince Rupert's Charge

Charge into history and do it in style. Be carried along with this unique action-packed group — a fine and authentic centre piece for your next ECW game.

EC1	Prince Rupert charging	22p
EC2	Trooper, pot helmet, charging with sword	22p
EC3	Trooper, pot helmet, firing pistol	22p
EC4	Trooper, bareheaded charging with sword	22p
EC5	Trumpeter	22p

EC6	Officer, in soft hat with sword	22p
EC7	Trooper, in soft hat with sword	22p
EC8	Trooper, in soft hat with pistol	22p
EC9	Standard bearer	22p
EC10	Trooper, falling wounded	22p

Suitable horses from the Foremost Range

FH7	Light Horse galloping	26p
FH8	Light horse trotting	26p
FH9	Light horse galloping, head back	26p

Fantasy (Fa)

Fa65	Ogre with double handed club	34p
Fa66	Wild wolf attacking	21p
Fa68	Skeleton defending with spear	17p

BARGAIN ARMY OF THE MONTH

Continue to beat the spiralling costs of metal, labour and postage — take advantage of this monthly bargain spot.

This month the offer is for an Ancient 25mm Army from the list below.

All the figures are available on the usual terms but buy a £25 lot or more from this listing and you enjoy free postage, a 10% discount and three free artillery pieces of our choice.

Your great chance to begin an army or add to the one you already own from the greatest figures on the market today.

All horses are 21p — choose them from our current listing or leave the choice to us.

Ancient Greek (AG), 17p per figure

AG1	Mercenary Hoplite
AG2	Spartan Hoplite
AG3	Cretan Archer
AG4	Agrinarian Javelinman
AG5	Thracian Peltast
AG6	Successor Phalangite
AG7	Mercenary Peltast with Thureus
AG8	Rhodian Slinger
AG9	Arab Mercenary Archer

AG10	Greek Officer
AG11	Greek Standard Bearer
AG12	Macedonian Phalangite
AG13	Hoplite 400 B.C. at rest
AG14	Light Peltast
AG15	Iphicratean Hoplite
AG16	Hypaspist

Ancient Greek Cavalry (AGC) 17p per figure

AGC1	Macedonian Companion Cavalry, AH7, AH8
AGC2	Dahae horse archer, AH7, AH8
AGC3	Selucid Arab Camelman
AGC4	Companion Cavalry with shield, AH7, AH8
AGC5	Thracian light cavalry, AH7, AH8
AGC6	Thracian light cavalry with sarissa, AH7, AH8
AGC7	Successor light cavalryman, AH7, AH8
AGC8	Selucid light cavalryman, AH7, AH8
AGC9	Sarmation Cataphract with Kontos and bow

Your chance to obtain one of the more colourful of the ancient armies. Defend the city walls of Athens or fight on the plains of Persia with the finest figures available today.



Our new 15mm range is ready for its first release — full listing in next month's ad. Send SAE now for a sample foot and cavalry figure.

We're planning lots of figures, guns, wagons and scenics.

When in London it's HQ for Hinchliffe

Jimmy Powell is the proprietor and he's waiting to serve you with the best in collecting and wargaming at

H.Q. 1a Craven Passage, Charing Cross, London WC2.

TO ALL OUR USA FRIENDS

We have our own manufacturing business in the USA, staffed by Americans anxious to advise and help you enjoy your hobby to the full. Give Cleve or Ed a call or drop a line to:

Hinchliffe Models Inc., 4824 Memphis, Dallas, Texas 75207 Tel: 634-1647.

Thank you for your interest in our new business. Orders have been overwhelming so please be patient we're shipping as fast as we can. Order early for the new 15's when they appear in October, sample offer applies also in U.S.A.

NEW 54M/M ADDITIONS TO SUDAN RANGE

54/JB11	Egyptian Fella of a Sudanese Battalion — firing
54/JB12	Egyptian Fella of a Sudanese Battalion — parrying with rifle and bayonet
54/JB13	Egyptian Officer of a Sudanese Battalion — firing revolver

54mm Sudan Range (54/JB) £2.50 each

54/JB1	British Line Infantry Officer
54/JB2	British Line Infantryman, dragging forward ammunition box
54/JB3	British Line Infantryman, withdrawing bayonet

54/JB4	British Line Infantryman, parrying with rifle across body.
54/JB5	British Line Infantryman, lying wounded
54/JB6	Dervish tribesman, attacking with spear and shield
54/JB7	Dervish tribesman, attacking with sword and shield
54/JB8	Dervish tribesman, falling wounded
54/JB9	Dervish tribesman, standing with sword and shield
54/JB10	Dervish tribesman, laying wounded — with standard



OUR SOLE AUSTRALIAN AGENTS BATTLEFIELD, 50 CLISSOLD PARADE, CAMPSIE, N.S.W. 2194, AUSTRALIA
SOLE UK AGENTS FOR LABAYEN FIGURES, WRITE FOR LISTING ENCLOSING S.A.E.

Sep 79

CALDER CRAFT

THE NEW NAME FOR MILITARY MODELLING

Son of Hinchcliffe Models, Calder Craft presents a compact range of military modelling and wargaming figures and equipment from 1/72 scale to 1/32 scale, all authentically reproduced in hand crafted white metal. Shown here are just a few examples from the exciting new Calder Craft collection.

A range of superbly detailed 1/32 scale guns (compatible to 1/35 scale) featuring the French Napoleonic 12 pdr.

These gun kits, excellent examples of fine craftsmanship, contain full assembly instructions and complete historical and technical details. This range will soon be enlarged and at a recommended retailing price of £4.95 each, this range is an attractive proposition for any collector.

1/32 GUNS Equipment Range

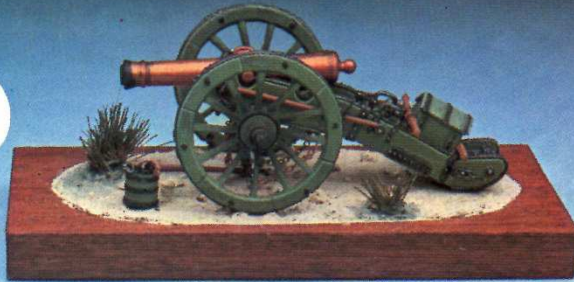

Model Code 5451
British 9pdr. gun Waterloo/Crimea
1798/1860. RRP £4.95



Model Code 5452
French Napoleonic 6'' Howitzer.
RRP £4.95



Model Code 5453
French Napoleonic 12pdr. gun.
RRP £4.95



Model Code 5454
British 18pdr. Field Gun WWI.
RRP £4.95



Model Code 5455
British 13pdr. Field Gun WWI.
RRP £4.95



Model Code 5456
German World War II 150mm Howitzer.
RRP £4.95



Taisho

SAMURAI

Warrior

Model Code RLO1

This masterpiece has already been acclaimed as the finest example of a Japanese Samurai Warrior ever to be produced. The magnificent kit contains full historical details, assembly and painting instructions for this Warrior Commander circa 1159-1190. RRP £18.00

These and many more models show the true quality and craftsmanship that ranks as amongst the highest in the world today.

So, if you're into modelling, get into Calder Craft – the new name in Military Modelling – for beginners and experts alike.

Available through all leading model shops – send for **FREE** Leaflet to:
CALDER CRAFT, A DIVISION OF HINCHLIFFE MODELS, MELTHAM, HUDDERSFIELD, HD7 3NX, ENGLAND.

Sep 79

CALDER CRAFT

THE NEW NAME FOR MILITARY MODELLING

Son of Hinchliffe Models, Caldercraft presents a compact range of military modelling and wargaming figures and equipment from 1/72 scale to 1/32 scale, all authentically reproduced in hand crafted white metal.

Shown here are just a few examples from the exciting new Calder Craft collection.

The 1/72 scale models include equipment from British, German and Russian armies and figure groups from the British and German armies; whilst the 25mm Adventure Packs and Booklets involve Napoleonic, Medieval, Robin Hood and Fantasy subjects.

The quality and craftsmanship of these and all the Calder Craft ranges is regarded as amongst the highest in the world today.

Look for the magnificent Diorama Kits featuring the German WWII Gun Team Horses and Crew, the first of its kind ever to be offered to collectors, or, the amazing Japanese Warrior Commander, acclaimed as the finest Samurai Warrior ever to be produced.

WORLD WAR II FIGURES AND EQUIPMENT

Designed to be used with all models of 1/72 scale both plastic and metal, the new, superior range is wholly concerned with the second world war. The figures and equipment, accurate in every detail, are skin packed and colour coded to make it easy for you to select and collect your battle groups.

1/72



Model Code 2101
British Infantry Section (10 figures).
1 NCO, 1 Bren Gunner, 4 Infantry
advancing, 4 Infantry firing.
RRP £1.20



Model Code 2108
German heavy machine gun group
(3 machine guns, 7 figures)
3 machine guns, 6 machine gunners,
1 NCO with binoculars. RRP £1.20



Model Code 2001
German WWII 10.5cm light
field Howitzer L28. RRP £1.20



Model Code 2004
German WWII 7.5cm PAK 40 L/46.
RRP £1.20

25mm

ADVENTURE PACKS & BOOKLETS

Through these adventure packs and booklets Calder Craft enter the fascinating and enthralling world of adventure gaming. The informative booklets give historical details, specific painting instructions, hints, tips and rules of play to set the scene for collecting these enchanting ranges, all of which are colour coded for easy selection... the more packs you collect the more involved and exciting the games become - it's easy and it's fun...

The Robin Hood board game takes adventure gaming a stage further. The comprehensive rules are simple to follow and allow different games to be played on the same board. All these game pieces are hand painted and you can add to them from the 25mm Robin Hood Adventure Pack range.

So, if you're into modelling, get into Calder Craft - the new name in military modelling - for beginners and experts alike. Available through all leading model shops - send for FREE leaflet to:-



Model Code 303
(Colour Code Red, Range of 48). Napoleonic, Russian Foot Artillery 1812-1815. 5 pieces. RRP £1.30



Model Code 1000
(Colour Code Dk. Green, Range of 12). Medieval English Men at Arms, Agincourt period. 8 pieces. RRP £1.30



Model Code 1100
(Colour Code Lt. Green, Range of 10). Robin Hood Personality Pack, Robin Hood, Little John, Friar Tuck etc., 7 pieces. RRP £1.30

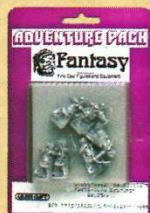

Model Code 1516
(Colour Code Purple, Range of 20). Fantasy, Elf Bowman, 6 pieces. RRP £1.30



Model Code 1601
(Colour Code Black). Accessory Pack, 1 Battle Pad, 1 Dice, 12 Casualty Caps, 6 Foot Bases, 2 Cavalry Bases, 20 pieces. RRP £1.30

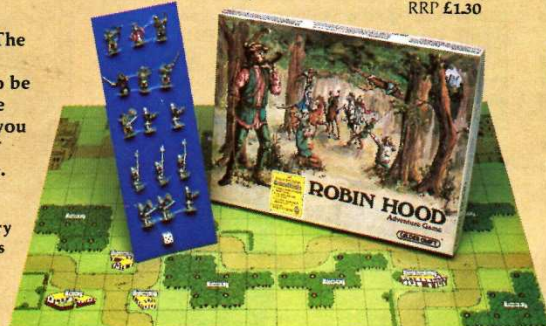

Price for booklets RRP 90p each Robin Hood Game RRP £7.95

Calder Craft, A division of Hinchliffe Models, Meltham, Huddersfield, HD7 3NX, England



HINCHLIFFE MODELS LTD

MELTHAM, HUDDERSFIELD, ENGLAND HD7 3NX

Jan 80

- Something New - Something Old



75/C2 Assyrian Medium Horse Archer
75mm £14.50

Just a small selection from our vast range designed by Lamb, Knight, Benassi, Jarvis, Hinchliffe and Gilder. - Names to conjure with and still the leaders!

Price list 25p plus 9p p.&p.
Handbook £3.00 plus 40p p.&p.
Hobby spray 6 oz. tin matt varnish white primer - 80p plus 9p p.&p.



76/JBC4 French Napoleonic Chasseur a Cheval
75mm £14.50



8007
13th Century Mounted Knight
80mm £22.00

New
54mm British 18 pdr. Gun 1800-1850 on wooden garrison carriage Model code ME/G/22.
Kit includes hand spike, rammer and slow match tub.
Another new gun and full crew next month.

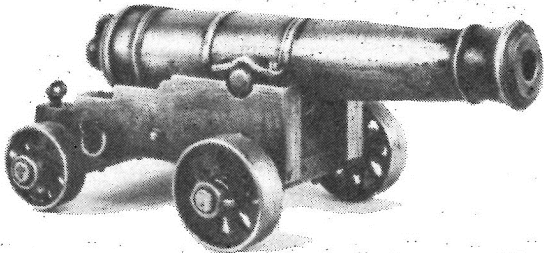

90/DJ6 Life Guards Trooper 1815
90mm £7.50



75/JB13 Landsknecht
75mm £5.00

When in London it's H.Q. Jimmy Powell is the proprietor and he's waiting to serve you with the best in collecting and wargaming at H.Q., la Carven Passage, Charing Cross, London WC2. Open Tuesday to Saturday 11.00am to 5.30pm.

Our sole Australian agents:
Battlefield, 50 Clissold Parade, Campsie, N.S.W. 2194, Australia.

U.S.A.

For prompt courteous service ring Ed or Cleve 214-634-164 or write to Hinchliffe Models Inc., 4824 Memphis Street, Dallas, Texas 75207.
- make a note in your calendar for March 1980 and see us at the M.F.C.A. Convention in Chester, PA. Lots of new large collectors items now available as listed in Military Modelling past and present plus the finest 15mm and 25mm wargame ranges, plus 20mm WWII plus, plus, plus . . .



HINCHLIFFE MODELS LTD

MELTHAM, HUDDERSFIELD, ENGLAND HD7 3NX

Feb 80

- Something New - Something Old



75/C2 Assyrian Medium Horse Archer
75mm £14.50

Just a small selection from our vast range designed by Lamb, Knight, Benassi, Jarvis, Hinchliffe and Gilder. - Names to conjure with and still the leaders!

Price list 25p plus 9p p.&p.
Handbook £3.00 plus 40p p.&p.
Hobby spray 6 oz. tin matt varnish white primer - 80p plus 9p p.&p.



76/JBC4 French Napoleonic Chasseur a Cheval
75mm £14.50



8007
13th Century Mounted Knight
80mm £22.00

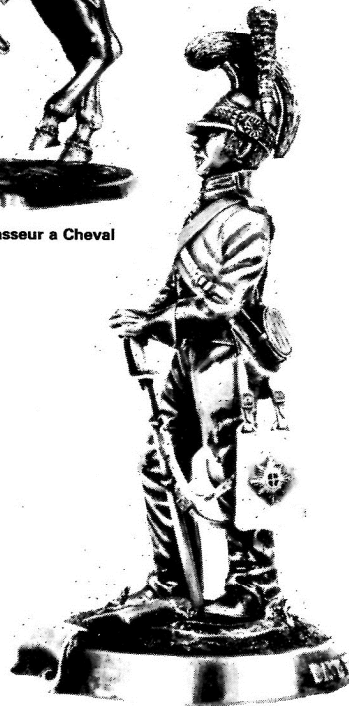

90/DJ6 Life Guards Trooper 1815
90mm £7.50

New
54mm British 18 pdr. Gun 1800-1850 on wooden garrison carriage Model code ME/G/22.
Kit includes hand spike, rammer and slow match tub.
Another new gun and full crew next month.

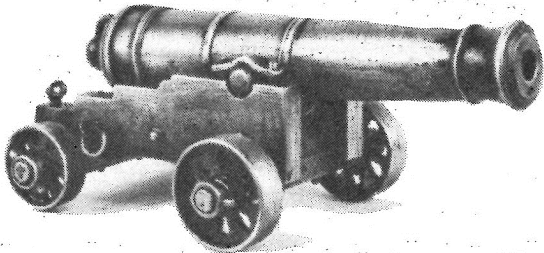

75/JB13 Landsknecht
75mm £5.00

When in London it's H.Q. Jimmy Powell is the proprietor and he's waiting to serve you with the best in collecting and wargaming at H.Q., la Carven Passage, Charing Cross, London WC2. Open Tuesday to Saturday 11.00am to 5.30pm.

Our sole Australian agents:
Battlefield, 50 Clissold Parade, Campsie, N.S.W. 2194, Australia.

U.S.A.
For prompt courteous service ring Ed or Cleve 214-634-164 or write to Hinchliffe Models Inc., 4824 Memphis Street, Dallas, Texas 75207.
- make a note in your calendar for March 1980 and see us at the M.F.C.A. Convention in Chester, PA. Lots of new large collectors items now available as listed in Military Modelling past and present plus the finest 15mm and 25mm wargame ranges, plus 20mm WWII plus, plus, plus . . .



HINCHLIFFE MODELS LTD

MELTHAM, HUDDERSFIELD, ENGLAND HD7 3NX

Mar 80

NEW 80mm

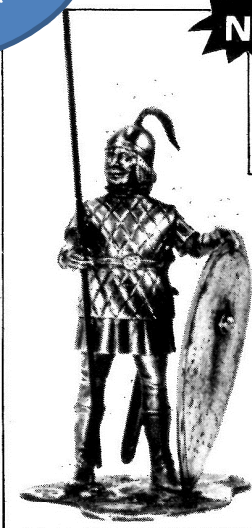

- ¹ 8009 Byzantine warrior 11th Century
- ² 8010 Baylors dragoon officer 1778

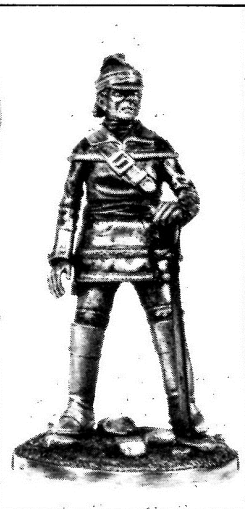

U.S.A.

For prompt courteous service ring Ed or Cleve 214-634-164 or write to Hinchliffe Models Inc, 4824 Memphis Street, Dallas, Texas 75207

SPANISH RENAISSANCE NEW 25mm WARGAME ARMY

- | | |
|--|--|
| Renaissance (RE) | Renaissance Cavalry (REC) |
| RE36 Spanish medium pikeman | REC22 Burgundian gendarme MH10 |
| RE37 Spanish heavy pikeman | REC23 Burgundian mounted archer MH7 |
| RE38 Spanish arquebusier | REC24 Italian gendarme MH10 |
| RE39 Spanish crossbowman | REC25 Spanish knight Mh10 |
| RE40 Spanish halberdier | REC26 Spanish mounted aquebusier MH7 |
| RE41 Spanish officer | |
| RE42 Spanish standard bearer | Horse |
| RE43 Spanish sword buckler man | MH10 Renaissance full plate armour horse |
| RE44 Burgundian pikeman with shield | |
| RE45 Burgundian pikeman | |
| RE46 Burgundian crossbowman | |
| RE47 Burgundian halberdier | |
| RE48 Burgundian mounted archer on foot | |



NAPOLEONIC 15mm

- | | |
|---------------------------------------|--|
| C15/23 French guard lancer | C15/28 French Guard Empress Dragoon Officer |
| C15/24 French guard lancer officer | C15/29 French Guard Grenadier a Cheval |
| C15/25 French Guard Chasseur a Cheval | C15/30 French Guard Grenadier a Cheval Officer |
| C15/26 French Guard Chasseur officer | C15/31 French Guard Marmaluke |
| C15/27 French Guard Empress Dragoon | |

Don't forget the other figures in this series like the Parachute Private Arnhem 1944 8005

Our Sole Australian Agents: Battlefield, 50 Clissold, Parade, Campsie, NSW 2194



54mm Egyptian officer and two Soudanese Priv. 1884

Apr 80



HINCHLIFFE MODELS LTD

MELTHAM, HUDDERSFIELD, ENGLAND HD7 3NX

20mm (1/72nd) WORLD WAR II

ALL FIGURES ARE 16p EACH UNLESS OTHERWISE STATED

AMERICAN (A)

- A1 American infantry advancing, with marching pack
 A2 American infantry advancing, combat order
 A3 American infantry N.C.O., combat order, advancing
 A4 American infantry, combat order, kneeling firing
 A5 American infantry officer, combat order, with binoculars
 A6 American infantry in Greatcoat with B.A.R.
 A7 American infantry in Greatcoat with rifle

BRITISH (B)

- B1 British infantryman, battle dress, advancing
 B2 British infantry N.C.O., battle dress, advancing
 B3 British infantryman, battle dress, kneeling
 B4 British infantryman, battle dress, lying firing
 B5 British infantry officer with revolver
 B6 British infantry N.C.O., with binoculars
 B7 British infantryman, lying firing Bren gun
 B8 British Paratrooper, advancing
 B9 British artilleryman, skeleton equipment, kneeling holding shell
 B10 British artillery N.C.O., skeleton equipment, manning gun
 B12 British artillery officer, skeleton equipment, with map board
 B13 British infantry carrying Bren gun
 B14 British infantry firing
 B15 British infantry kneeling with mortar bomb
 B16 British infantry carrying mortar case
 B17 British infantry officer pointing
 B18 British infantry fusing mortar bomb
 B19 British infantry firing Vickers machine gun
 B20 British infantry feeding ammo Vickers machine gun
 B21 British infantry with walkie-talkie
 B22 British infantry radio operators with command radio (two figures) (30p)
 B23 British infantryman with piat (30p)
 B24 British artilleryman with shell running
 B25 British commando with sten gun
 B26 British commando with rifle and bayonet

GERMANS (G)

- G1 German infantryman, advancing
 G2 German N.C.O. advancing with machine pistol
 G3 German Panzer Grenadier, advancing
 G4 German infantryman, kneeling
 G5 German artilleryman, hands over ears
 G6 German artilleryman, kneeling
 G7 German artilleryman, with rangefinder
 G8 German officer, slung binoculars
 G9 German paratrooper, advancing
 G10 German infantryman, carrying ammo boxes
 G11 German artilleryman with binoculars
 G12 German infantryman firing panzer faust
 G13 German infantryman, panzer faust loader
 G14 German infantry with LMG
 G15 German infantry marching, slung rifle
 G16 German Panzer grenadier N.C.O.
 G17 German Panzer Grenadier LMG and crew firing (double figure) (30p)
 G18 German Panzer firing
 G19 German Panzer advancing assault file
 G20 German infantry kneeling with mortar bomb
 G21 German infantry N.C.O. with binoculars
 G22 German infantry carrying mortar bombs
 G23 German infantry fusing mortar bomb
 G24 German infantry firing machine gun
 G25 German infantry feeding ammo. Machine gun
 G26 German infantry with panzerfaust
 G27 German infantry officer with map
 G30 German field police
 G31 German infantry radio operator with radio (30p)
 G32 German infantry radio operator assistant
 G33 German artilleryman kneeling with round
 G34 German artilleryman standing with round
 G35 German artilleryman manning gun

RUSSIANS (RU)

- RU1 Russian infantry in greatcoat, advancing
 RU2 Russian infantry in greatcoat, advancing with sub-machine gun
 RU3 Russian Infantry Officer in greatcoat, advancing
 RU4 Russian Artilleryman with shell
 RU5 Russian Artilleryman kneeling
 RU6 Russian Artilleryman with binoculars

INFANTRY WEAPONS

- 20/22 German W.W.II 10.5cm Light Field Howitzer L/28 £1.60
 20/23 German W.W.II 150mm Nebelwerfer £1.30
 20/24 German W.W.II 7.5cm Light Infantry gun £1.30
 20/25 German W.W.II 7.5cm PAK 40 L/46 £1.30
 20/26 German W.W.II 8.8cm PAK 43/31 L/71 £1.60
 20/27 British W.W.II 17 pdr. Anti-Tank gun £1.60
 20/28 German W.W.II Hanomag 251/1 £2.00
 20/29 British W.W.II 7.2" Howitzer £1.60
 20/30 Russian W.W.II 7.62cm Howitzer £1.60
 20/31 British Vickers machine gun tripod mounted with water condenser 45p
 20/32 German MG42 machine gun on heavy mounting 45p
 20/33 Medium mortar, barrel & sights, base plate and elevating bipod 45p

30mm EQUIPMENT RANGE

IDEAL FOR OUR 'FOURMOST' RANGE

- 30/1 British 9 pdr. gun Napoleonic/Crimea £1.10
 30/2 British limber Napoleonic/Crimea £1.10
 30/3 British 3 pdr. Galloper gun 1700-1790 £1.10
 30/4 British 24 pdr. gun 1700-1790 £1.10
 30/5 British 8" Howitzer 1700-1790 £1.10
 30/6 British limber 1700-1790 80p
 30/7 British Pontoon wagon 1700-1790 £2.50
 30/8 French Napoleonic 8 pdr. gun £1.10
 30/9 French Napoleonic 12 pdr. gun £1.10
 30/11 British 6 pdr. gun Napoleonic/Crimea £1.10
 30/12 British Spare Wheel Carriage Napoleonic/Crimea £1.10

20mm EQUIPMENT RANGE

- 20/1 British Napoleonic 6 pdr. gun 65p
 20/2 British Napoleonic 9 pdr. gun 65p
 20/3 British Napoleonic 10" Howitzer £1.00
 20/4 French Napoleonic 8 pdr. gun 65p
 20/5 French Napoleonic 12 pdr. gun 65p
 20/6 French Napoleonic 10" Mortar 65p
 20/7 British Napoleonic limber 65p
 20/8 French Napoleonic limber 40p
 20/9 French Napoleonic ammunition caisson £1.00
 20/10 British Napoleonic ammunition wagon 65p
 20/11 British Napoleonic 5.5" Howitzer 65p
 20/12 French Napoleonic 6" Howitzer 65p
 20/13 French Napoleonic 8" Howitzer 65p
 20/14 British Napoleonic spare wheel carriage 65p
 20/15 British Colonial Elephant Team and 40 pdr. gun £4.50
 20/16 British Colonial Elephant Team and 6.3" Howitzer £4.50
 20/17 English Civil War, medium gun 65p
 20/18 British RML 6.3" Howitzer 1870-90 £1.00
 20/19 British RML 40 pdr. gun 1870-90 £1.00
 20/20 English Civil War, heavy gun 65p
 20/21 British Colonial Baggage Wagon £1.50

FANTASY (FA)

- FA1 Dwarf with sword and shield 20p
 FA2 Dwarf with bow 17p
 FA3 Dwarf with spear 20p
 FA4 Dwarf on journey with donkey 43p
 FA5 Frost giant with hammer and shield 40p
 FA6 Frost giant with axe 40p
 FA7 Ogre with club 40p
 FA8 Centaur with bow 54p
 FA9 Centaur with club 54p
 FA10 Armoured centaur 40p
 FA11 Good Wizard with owl 18p
 FA12 Sorcerer 18p
 FA13 Giant with club 1.70
 FA14 Winged demon 21p
 FA15 Evil winged demon 21p
 FA16 Large tree man 85p
 FA17 Goblin with glave 20p
 FA18 Double headed dragon £1.60p
 FA19 Small tree man 54p
 FA20 Savage wolf 27p
 FA21 Wood Elf with bow 20p
 FA22 Wood Elf with spear and shield 20p
 FA23 Mounted Northern warrior 54p
 FA24 Sorcerer on donkey 43p
 FA25 Bad Wizard on horse 54p
 FA26 Bad Wizard 27p
 FA27 Goody horseman with lance and shield 54p
 FA28 Follower of evil with sword 27p
 FA29 Little people with bow 18p
 FA30 Little people with spear 18p
 FA31 Little people with bundle 18p
 FA32 Little people, woman 18p
 FA33 Dwarf with axe 18p
 FA34 Hero with sword 18p
 FA35 Adventurer with sword and shield 18p
 FA36 Adventurer with bow 18p
 FA37 Armoured Goblin with spear 27p
 FA38 City Guard, with spear 27p
 FA39 Little people with sword 18p
 FA40 Little people on journey 18p
 FA41 Little people with bundle in cloak 18p
 FA42 Elf on journey 18p
 FA43 City Guard with sword 27p
 FA44 Armoured Goblin with sword 27p
 FA45 Yonderley man with sword and shield 27p

- FA46 Yonderley man with spear and shield 27p
 FA47 Cohort of the grave with spear 20p
 FA48 Assassin with knife 17p
 FA49 Goblin in wild wolf 36p
 FA50 Dwarf lancer on pony 36p
 FA51 Adventurers with sword 17p
 FA52 High Priestess 17p
 FA53 Skeleton with sword 27p
 FA54 Dwarf on Journey 17p
 FA55 Super hero wielding axe 17p
 FA56 Frost giant with double handed sword 17p
 FA57 Hobgoblin with sword and shield 34p
 FA58 Goblin with bow 17p
 FA59 Female Centaur with bow 43p
 FA60 Skeleton with glave 17p
 FA61 Forester with bow 17p
 FA62 Skeleton with hood and cloak 17p
 FA63 Ogre throwing rock 34p
 FA64 Dwarf with round shield and spear 17p
 FA65 Ogre with double handed club 34p
 FA66 Wild wolf attacking 17p
 FA68 Skeleton man defending with spear 17p

NEW ADDITIONS

54mm EQUIPMENT RANGE FRENCH NAPOLEONIC GALLOPING GUN TEAM

- H/W Near wheel horse £4.00
 H/X Off wheel horse £4.50
 H/Y Near lead horse £4.50
 H/Z Off lead horse £4.50
 R13 Lead driver £2.90
 R14 Wheel or rear driver £2.90
 All necessary harness parts included with each horse
 C9 German mounted officer WWII £6.00
 C10 French mounted trumpeter of the line 1812 £6.00
 ME/G/22 British 18 pdr. gun on wooden garrison carriage 1800-1850 £5.80
 ME/G/23 British 18 pdr. naval gun 1800-1850 £5.80
 ME/G/24 French Napoleonic 8 pdr. gun £5.80
 F70 British naval officer 1805 £2.90
 F71 British midshipman with speaking trumpet 1805 £2.90

- F72 Naval gunner - pulling lanyard 1805 £2.90
 F73 Seaman/Gunner - with rope 1805 £2.90
 F74 Seaman/Gunner - with rammer/sponge 1805 £2.90
 F75 Seaman/Gunner - with large hand lever 1805 2.90
 F76 Ships boy with powder charge 1805 £2.90
 F69 French nap, fusilier in greatcoat £2.90

25mm RANGE SARMATIONS (SA)

- SA1 Irregular archer firing bow
 SA2 Axeman charging
 SA3 Axeman swinging axe

SARMATION CAVALRY (SAC)

- SAC1 Armoured cavalry, charging
 SAC2 Armoured cavalry, thrusting
 SAC3 Armoured cavalry, firing bow
 SAC4 Light cavalry with bow

ANCIENT HORSES (AH)

- AH17 Half armoured horse charging
 AH18 Half armoured horse reining in

VIKINGS (AV)

- AV5 Huscarle, double handed axe, charging
 AV6 Bondi, medium infantry with shield & javelin
 AV7 Slinger
 AV8 Light infantry javelinman

25mm FOREMOST (One piece castings)

- RS1 Royal Scots Greys charging - officer
 RS2 Royal Scots Greys charging - trumpeter
 RS3 Royal Scots Greys charging - guidon bearer
 RS4 Royal Scots Greys charging - trooper
 RS5 French carabinier charging - officer
 RS6 French carabinier charging - trumpeter
 RS7 French carabinier charging - guidon bearer
 RS8 French carabinier charging - trooper

Our sole Australian agents:
 Battlefield, 50 Clissold Parade, Campsie,
 N.S.W. 2194, Australia

U.S.A.
 For prompt courteous service ring Ed or Cleve 214-634-164 or write to Hinchliffe Models Inc., 4824 Memphis Street, Dallas, Texas 75207.

OUR ON THE PREMISES SHOP
 OPEN MON. TO FRI. 9.30a.m. TO 5.00p.m.
 SATURDAY 9.30a.m. TO 12.30p.m. ONLY

GUIDE TO WARGAMING

50p + 15p p&p

PRICE LISTS

25p + 10p p&p

HANDBOOK

£2.75p + 40p p&p

Most items will be despatched within 7-14 days or sooner but certain items may take a little longer, please allow up to 28 days for delivery.



HINCHLIFFE MODELS

MELTHAM, HUDDERSFIELD, ENGLAND HD7 3NX

May 80

SOMETHING A LITTLE DIFFERENT

A Collection of late Victorian Vignettes

- No. 1 Plough Horse and Farmer **£17.25**
- No. 2 Blacksmith and Apprentice (as illustrated) **£15.60**
- No. 3 Street Musician **£15.60**
- No. 4 River Punt Scene **£17.25**
- No. 5 Hill Shepherd **£15.60**

(In Kit Form)



(Scale approx. 80/90mm)

DIRECT MAIL ORDER BY PHONE OR POST

Most items will be despatched within 7-14 days or sooner but certain items may take a little longer. Please allow up to 28 days for delivery.



Hinchliffe Models Ltd.

21 Station Street, Meltham, Huddersfield, England, HD7 3NX

Jun 80

NEW 25mm RELEASES PLUS A FEW REMAKES IN AND AMONG

Dutch, Belgian, Napoleonic (DBN) 17p each

- DBN1 Line Private advancing
- DBN2 Line Private charging
- DBN3 Line Officer, Dutch, advancing
- DBN4 Flanquer in skirmish order kneeling firing
- DBN5 Belgian Infantry charging
- DBN6 Belgian Infantry drummer
- DBN7 Militia Private charging
- DBN8 Drummer marching drum over shoulder
- DBN9 Artilleryman with shot
- DBN10 Artilleryman with rammer
- DBN11 Artilleryman with manning gun
- DBN12 Artilleryman with bucket
- DBN13 Artillery Officer
- DBN14 Line Infantry standard bearer **34p**
- DBN15 Militia Infantry standard bearer **34p**

Dutch Belgian Napoleonic Cavalry (DBNC) 17p per figure

- DBNC1 Carabinier, Trooper, H1, H2, H6
- DBNC2 Carabinier, Officer, H1, H2, H6
- DBNC3 Carabinier, Trumpeter, H1, H2, H6
- DBNC4 Light Dragoon
- DBNC5 Light Dragoon Officer
- DBNC6 Light Dragoon Trumpeter

Brunswick Napoleonic (BRN) 17p each

- BRN12 Horse Artillery with Round
- BRN13 Horse Artillery with Rammer
- BRN14 Horse Artillery with Bucket
- BRN15 Horse Artillery with Portfire

IN JUNE
75mm French Napoleonic Gun – the Gribeauval 12 pdr.

IN JULY
54mm German 2cm Flak 30

Price list 25p plus 10p p&p.
Hinchliffe Handbook £3.00 plus 50p p&p.

D.M.O.
10% on all orders under £10.
Post free over £10.

U.S. Customers: Hinchliffe Model Inc. 4824
Memphis Street, Dallas, Texas 75207
Australia: Battlefield 50 Clissold Parade,
Campsie, NSW 2194.



NEW RELEASE – Fully Boxed – Full instructions – Terrained base

FRENCH NAPOLEONIC FORGE-DE-CAMPAIGN

MODEL CODE 5408



1:32nd SCALE

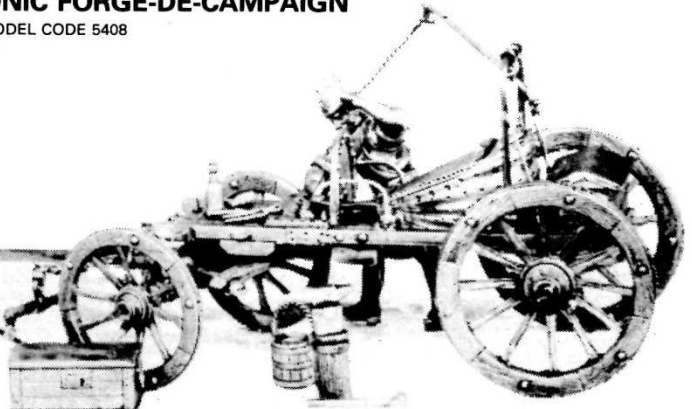
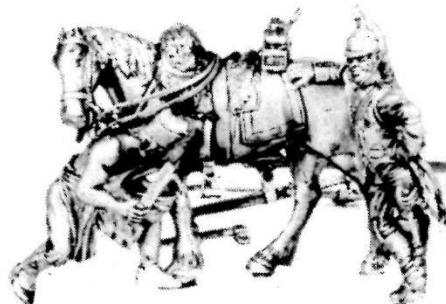

Aug 80

MELTHAM, HUDDERSFIELD, ENGLAND HD7 3NX

25mm NEW RELEASES!

Confederation of the Rhine (CR) figures 17p each.

- CR1 Saxon fusilier
- CR2 Saxon grenadier
- CR3 Saxon infantry officer
- CR4 Wurzburg fusilier
- CR5 Wurzburg flank Co.
- CR6 Wurzburg infantry officer
- CR7 Wurttenburg musketeer
- CR8 Wurttenburg grenadier
- CR9 Wurttenburg infantry officer
- CR10 Wurttenburg jaeger
- CR11 Nassau fusilier
- CR12 Nassau grenadier
- CR13 Nassau infantry officer

Confederation of the Rhine cavalry (CRC) figures 17p each

- CRC1 Saxon cuirassier
- CRC2 Saxon cuirassier officer
- CRC3 Wurttenburg chevaulegers
- CRC4 Wurttenburg chevaulegers officer
- CRC5 Berg lancer
- CRC6 Berg elite lancer
- CRC7 Berg lancer officer

Renaissance (RE) figures 17p each

- RE49 Burgundian hand gunner
- RE50 Swiss hand gunner

Renaissance cavalry (REC) figures 17p each

- REC27 Coustilier
- REC28 Burgundian cross bowman

The majority of the infantry figures for this army can be taken from our standard French Infantry. Bavarians may also be taken from our existing range.

FIRST: PKO/1 THE GOTHIC KNIGHT. NOW! PKO/2 PRIVATE 24th FOOT AT RORKES DRIFT 1879

Scale: 120mm



Model code PKO/2 is available at your retailer or direct at £16.00.

MODELS THAT SPEAK FOR THEMSELVES

TWO **NEW** 75mm NAPOLEONIC GUNS

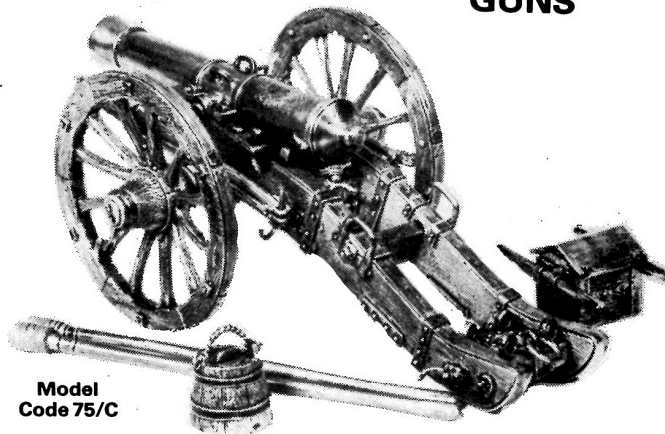

Model Code 75/C

**FRENCH NAPOLEONIC 12PDR. CANNON.
OUR BEST ARTILLERY PIECES TO DATE!
WHERE BIG IS BEAUTIFUL.**

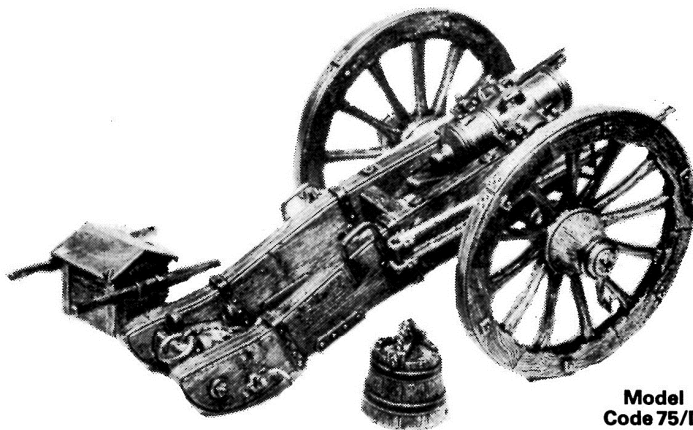

Model Code 75/D

FRENCH NAPOLEONIC 6" HOWITZER.

Each model is a 40 plus kit – easy to assemble – full instructions. ONLY £15.00

NEXT MONTH!

54mm German WWII Flak 30

SEND TODAY FOR OUR FULL PRICE LIST 25p plus 10p p&p.
HINCHLIFFE HANDBOOK £3.00 plus 40p p&p.

HOBBY SPRAY WHITE PRIMER & MATT VARNISH
6oz. can 75p plus 12p p&p.

Visit our on the premises shop open all week 9am – 5pm and Saturday mornings!
Direct Mail order post free over £10 10% under £10



**U.S.A. HINCHLIFFE MODELS INC. 4824 MEMPHIS STREET, DALLAS, TEXAS 75207
AUSTRALIA: BATTLEFIELD, CLISSOLD PARADE, CAMPSIE, N.S.W. 2194**



HINCHLIFFE MODELS LTD

21 STATION STREET, MELTHAM, HUDDERSFIELD, ENGLAND HD7 3NX

Nov 80



ECW34

Pike & Shot **NEW**

New items this month – A few more to add to our already considerable range – suitable for 30 Years War, Swedish and of course English Civil War.

October Releases

ECW25 Pikeman charging
ECW26 Pikeman advancing
ECW27 Musketeer priming pan
ECW28 Musketeer at rest

ECW29 Musketeer running
ECW30 Officer advancing
ECW31 Officer standing

ECW32 Drummer marching
ECW33 Dragoon running
ECW34 Firelock of Artillery Guard

SPECIAL OFFER

THIS MONTH ONLY!
(Closing date 28th November 1980)
ENGLISH CIVIL WAR ARMY
Containing many of the new figures listed above.

Consists of:-

2 Foot Regiments
2 Cavalry Regiments
Dragoon Regiments
Artillery Park and Firelock Guard

Price £26.00 (inc. P.&P.) A saving of at least 10% over buying items separately.

THESE ARMIES WILL BE AVAILABLE AT NORTHERN MILITAIRE '80

Also available in this range:-

English Civil War (ECW) 17p per figure

ECW1 Pikeman in helmet, pike forward
ECW2 Pikeman, in helmet, pike up
ECW3 Pikeman in plumed hat, pike forward
ECW5 Musketeer in helmet, firing
ECW6 Musketeer in helmet, at present
ECW7 Musketeer in plumed hat, firing
ECW8 Musketeer in plumed hat, at present
ECW9 Officer in helmet
ECW10 Officer in plumed hat
ECW11 Colour Bearer in helmet 34p
ECW12 Colour Bearer in plumed hat 34p
ECW13 Drummer in helmet
ECW14 Drummer in plumed hat
ECW15 Dragoon, firing
ECW16 Artilleryman, holding rammer
ECW17 Artilleryman, manning gun
ECW18 Artilleryman, firing gun
ECW19 Artilleryman, holding shot
ECW20 Musketeer, marching
ECW21 Pikeman, marching
ECW22 Pikeman, at east
ECW23 Musketeer loading
ECW24 Artilleryman with rammer

English Civil War Cavalry (ECWC) 17p per figure

ECWC1 Heavy Cavalry, at rest, LH1, LH3, LH4
ECWC2 Heavy Cavalry, charging, LH2, LH5
ECWC3 Heavy Cavalry Officer, LH1, LH2, LH3, LH5
ECWC4 Heavy Cavalry, Trumpeter, LH2, LH3, LH5
ECWC5 Light Cavalry, plumed hat, at rest, LH1, LH3, LH4
ECWC6 Light Cavalry, plumed hat, charging, LH2, LH5
ECWC7 Light Cavalry, plumed hat, Officer, LH2, LH3, LH5
ECWC9 Cuirassier, LH3, LH4
ECWC10 Cuirassier Officer, LH3, LH4
ECWC11 Dragoon, LH1, LH3, LH4
ECWC12 Mounted Dragoon Drummer, LH3, LH4
ECWC13 Carabinier, at rest, MH4, MH5
ECWC14 Heavy Cavalry, firing pistol MH4, MH5
ECWC15 Medium Cavalry with pistol MH4, MH5

Personality Figure (PF) 48p each

PF22 Prince Rupert and dog
PF23 General Fairfax

One Piece Cavalry (OPC) 36p each

OPC7 English Civil War Colonel
OPC33 English Civil War Parliamentarian Aide
OPC34 English Civil War King Charles
OPC37 English Civil War Oliver Cromwell
OPC38 English Civil War Parliamentarian General
OPC39 English Civil War Royalist General
EH7 Heavy Draft Horse

25mm Equipment

25/AO English Civil War Falcon (2-5 pdr. – Light gun).
25/AP English Civil War Limber 48p
25/AR English Civil War Heavy Mortar 86p
25/AS English Civil War Cannon Royale 96p
25/AT Pack of six powder barrels 48p
25/AU Pack of five gabions 48p

25mm Equipment Groups

EG9 English Civil War Shot barrow and attendant powder barrel, base grillage and 2 gabions £1.70
EG22 English Civil War Horse Drawn Wagon with 2 powder barrels, 1 driver gunner attendant sat on barrels & marker flag £1.70
EG24 English Civil War hand drawn cart with 2 powder barrels, 2 men pulling cart, 1 gunner in attendance & marker flag 96p
EG23 English Civil War hand drawn cart with small mortar, 2 men pulling & 1 gunner attendant, plus marker flag 96p

Foremost Figures 22p each

Prince Rupert's Charge

EC1 Prince Rupert charging
EC2 Trooper, Pot Helmet, charging with sword
EC3 Trooper, pot helmet, firing pistol
EC4 Trooper, bareheaded charging with sword
EC5 Trumpeter

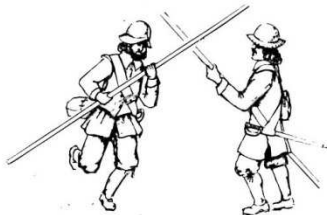

ECW25

ECW26



ECW27



ECW28



ECW29



ECW30



ECW31



ECW32

**northern
militaire '80**

Lancastrian Hall,
Swinton,
Manchester.
NOVEMBER 1st & 2nd

The one show in the year you must attend

DIRECT MAIL ORDER

Why not use our first class Omo service?
10% under £10; over £10 post free.

Barclaycard by telephone or with order.

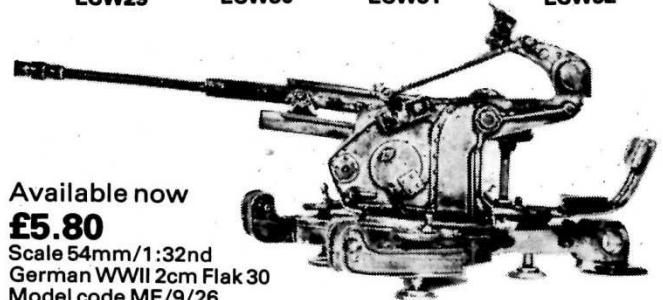

Available now

£5.80

Scale 54mm/1:32nd
German WWII 2cm Flak 30
Model code ME/9/26



HINCHLIFFE MODELS LTD

MELTHAM, HUDDERSFIELD, ENGLAND HD7 3NX

Jan 81

THE GOTHIC KNIGHT (Now with modified Banner)

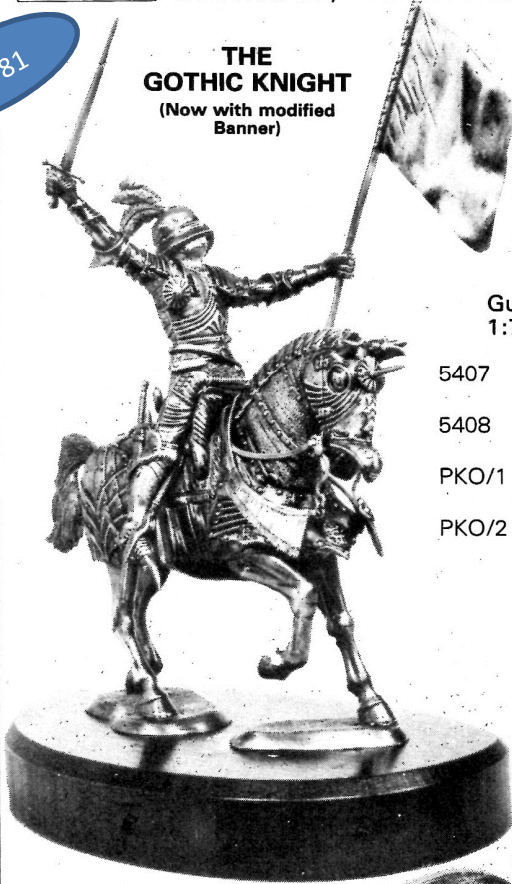

CALDER CRAFT®

THINKING OF A CHRISTMAS GIFT?

Look no further – our full Calder Craft range is available in your local retailer now – fully boxed – each kit is complete with base and full instructions.

Guns – Gun teams – Diorama Packs –
1:72nd WWII Artillery & Figures.

- 5407 French Napoleonic 12pdr galloping gun team. **£32.00 complete.**
- 5408 French Napoleonic Forge-de-Campaign. **£23.15 complete.**
- PKO/1 Gothic Knight **£29.00 complete with polished mahogany base.**
- PKO/2 Private 24th Foot at Rorkes Drift 1879 scale 120mm **£16.00.**

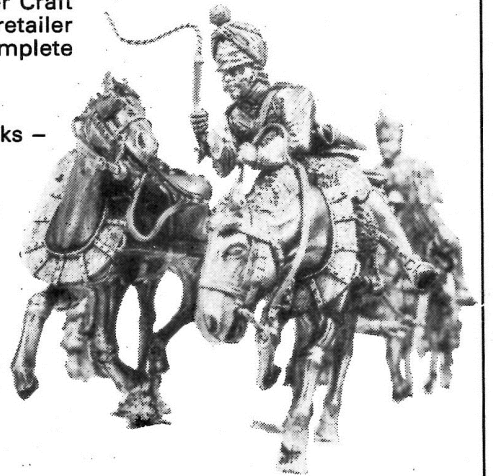

OUR LATEST 25mm RELEASES can be found in our update list.

SAMATIONS – CONFEDERATION OF THE RHINE – VIKINGS – ENGLISH CIVIL WAR – AMERICAN CIVIL WAR – RENAISSANCE – BAVARIAN

75mm NAPOLEONIC GUNS

Each Gun kit consists of 40 plus parts. Easy to assemble – full instructions

ONLY £15.00

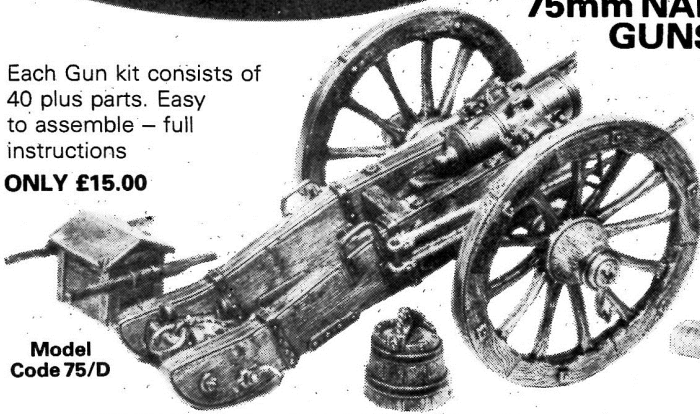

Model Code 75/D

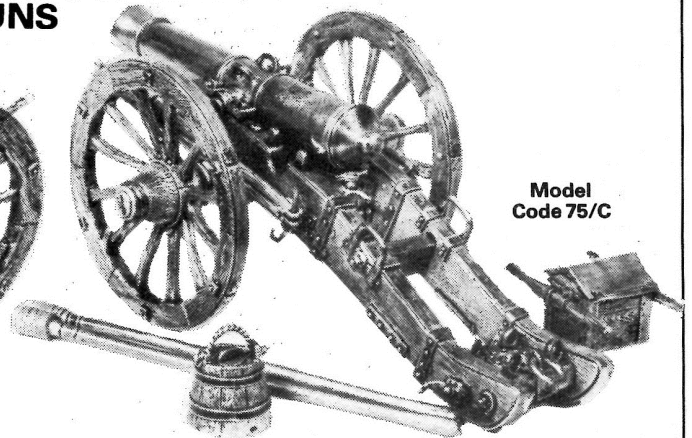

Model Code 75/C

FRENCH NAPOLEONIC 6" HOWITZER.

FRENCH NAPOLEONIC 12PDR. CANNON.

SEND TODAY FOR OUR FULL PRICE LIST 25p plus 10p p&p.

HINCHLIFFE HANDBOOK £3.00 plus 40p p&p.

HOBBY SPRAY WHITE PRIMER & MATT VARNISH

6oz. can 75p plus 12p p&p.

Visit our on the premises shop open all week 9am – 5pm and Saturday mornings.

Direct Mail order post free over £10 10% under £10

Full range of Davco tanks also available worth a call if you're passing.

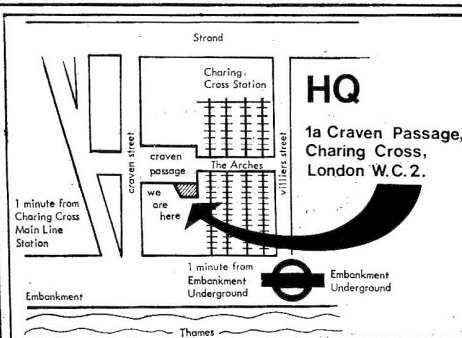

WHEN IN LONDON THIS MONTH CALL IN AND SEE OUR FULL RANGE OF MODELS! PLUS ALL OUR UP-TO-DATE RELEASES.

U.S.A. HINCHLIFFE MODELS INC. 4824 MEMPHIS STREET, DALLAS, TEXAS 75207
AUSTRALIA: BATTLEFIELD, CLISSOLD PARADE, CAMPSIE, N.S.W. 2194

Feb 81



HINCHLIFFE MODELS LTD

MELTHAM, HUDDERSFIELD, ENGLAND HD7 3NX

THIS MONTH



15mm RUSSIAN NAPOLEONIC INFANTRY

FRENCH AND BRITISH NAPOLEONIC INFANTRY CAVALRY INFANTRY - 7p GUNS (3 per pack) 75p CAVALRY - 14p

RUSSIAN INFANTRY

- 15/40 Musketeer in Greatcoat & Fatigue Cap Advancing
- 15/41 Line Officer in Greatcoat & Fatigue Cap
- 15/42 Line Grenadier Advancing
- 15/43 Line Grenadier Officer
- 15/44 Musketeer Advancing
- 15/45 Musketeer Charging
- 15/46 Musketeer Officer
- 15/47 Musketeer in Greatcoat and Shako Advancing
- 15/48 Musketeer Officer in Greatcoat & Shako
- 15/49 Pavlov Grenadier Advancing
- 15/50 Pavlov Grenadier Officer
- 15/51 Line Jaeger Kneeling Firing
- 15/52 Artilleryman with Rammer
- 15/53 Artilleryman Manning Gun
- 15/54 Artilleryman with Shot
- 15/55 Artilleryman with Portfire

- 15/1 French Fusilier
- 15/2 French Grenadier of Voltigeur
- 15/3 French Officer
- 15/4 French Fusilier in Greatcoat & Shako Cover
- 15/5 French Grenadier in Greatcoat & Shako Cover
- 15/6 French Officer in Greatcoat & Shako Cover
- 15/7 French Old Guard
- 15/8 French Old Guard Officer
- 15/9 French Light Inf. firing
- 15/10 British Line Infantry
- 15/11 British Flank Co.
- 15/12 British Line Officer
- 15/13 British Fusilier
- 15/14 British Fusilier Officer
- 15/15 British Highlander Charging
- 15/16 British Highland Officer
- 15/17 British Rifleman firing
- 15/18 British Rifleman Officer
- 15/19 British Line in Greatcoat British Line Inf. in Greatcoat
- 15/20 British Line Officer
- 15/21 British Light Infantry advancing

- 15/22 British Light Infantry Officer
- 15/23 British Light Infantry firing
- 15/24 British Foot Artillery manning gun
- 15/25 British Foot Artillery with shot
- 15/26 British Foot Artillery with rammer
- 15/27 British Foot Artillery with portfire
- 15/28 British Horse Artillery manning gun
- 15/29 British Horse Artillery with shot
- 15/30 British Horse Artillery with rammer
- 15/31 British Horse Artillery with portfire
- 15/32 French Foot Artillery manning gun
- 15/33 French Foot Artillery with shot
- 15/34 French Foot Artillery with rammer
- 15/35 French Foot Artillery with portfire
- 15/36 French Artillery manning gun
- 15/37 French Horse Artillery with shot
- 15/38 French Horse Artillery with rammer
- 15/39 French Horse Artillery with portfire
- C15/1 French Hussar
- C15/2 French Hussar Officer
- C15/3 French Dragoon

- C15/4 French Dragoon Officer
- C15/5 French Chasseur
- C15/6 French Chasseur Officer
- C15/7 French Lancer
- C15/8 French Lancer Officer
- C15/9 French Cuirassier
- C15/10 French Cuirassier Officer
- C15/11 French Carabinier
- C15/12 French Carabinier Officer
- C15/13 British Light Dragoon
- C15/14 British Light Dragoon Officer
- C15/15 British Hussar
- C15/16 British Hussar Officer
- C15/17 British Dragoon
- C15/18 British Dragoon Officer
- C15/19 British Household Cavalry
- C15/20 British Household Cavalry Officer
- C15/21 British Scots Greys
- C15/22 British Scots Greys Officer
- C15/23 French Guard Lancer
- C15/24 French Guard Lancer Officer

NEW STYLE RETAIL PACKAGING:

Your 25mm figures are now available 3 to a pack. Officers, Drummers, Standard Bearers, etc., in balanced command packs. Horses in separate packs of three. Artillery crews in fives.

We hope that this restyled packing will help your retailer to stock a greater range and that you will have easier access to view the figures on display.

A retail price sheet is available giving details of prices - Command Packs - Artillery Packs, etc.
New prices for all our ranges: 25mm Figures 20p, Horses 25p. See our January 1981 price list for up-to-date prices and releases.

Sci-fi AVAILABLE NOW!

- | | | | |
|------|---|------|---|
| FA69 | Crostation Armoured Infantry with Ray Gun | FA75 | Crostation Armoured Infantry with Sword |
| FA70 | Mautierian Male with Telescopic Slicer | FA76 | Faunian Wizard Guard |
| FA71 | Mautierian Female with Zone Contaminator | FA77 | Federation Desert Shock Trooper |
| FA72 | Faunian Enchantress | FA78 | Star Guide with Laser Rifle |
| FA73 | Reptilian Rex Primary Hypnotiser | FA79 | Union Storm Trooper |
| FA74 | Mautierian Guard | FA80 | Federation Shock Trooper with Thermal Lance |
| | | FA81 | Female Entertainer |

75/JBC 8
French Napoleonic Mounted Gendarme (Army of Spain 1810)
£14.85

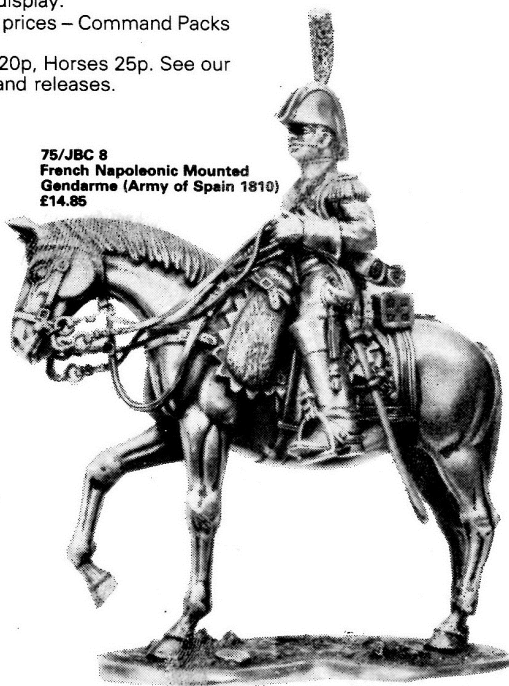

VISIT THE HINCHLIFFE MODELS Retail Shop.

Why should you visit our on-the-premises retail shop? Because it's got between 2½ to 3 thousand painted figures and models on illuminated display.
Plus - Davco Micro Armour from Skytrex and other accessories.

IN THE PIPELINE: 25mm Scots E.C.W.

120mm Mounted Samurai an incredible model

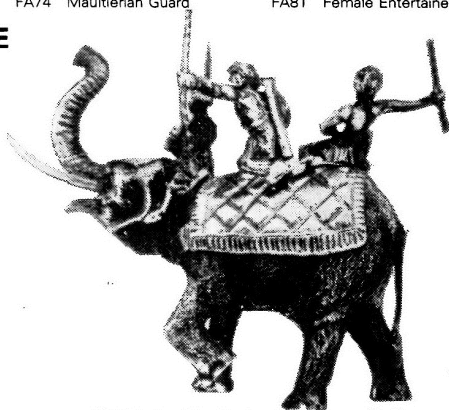

EG38 Indian War Elephant £2.00

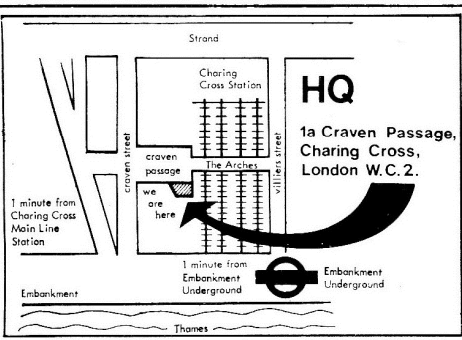

WHEN IN LONDON THIS MONTH CALL IN AND SEE OUR FULL RANGE OF MODELS! PLUS ALL OUR UP-TO-DATE RELEASES.

NEW VENUE FOR NORTHERN MILITAIRE '81

More space - more display - end of October
SEND TODAY FOR OUR FULL PRICE LIST 30p plus 12p p&p.
HINCHLIFFE HANDBOOK £3.00 plus 50p p&p.
HOBBY SPRAY WHITE PRIMER & MATT VARNISH 6oz. can 75p plus 14p p&p.

Visit our on the premises shop open all week 9am-5pm and Saturday mornings
Direct Mail order post free over £12. 10% under £12
Full range of Davco tanks also available worth a call if you're passing.



U.S.A. HINCHLIFFE MODELS INC. 4824 MEMPHIS STREET, DALLAS, TEXAS 75207
AUSTRALIA: RATTI FIELD, CLISSOLD PARADE, CAMPSIE, N.S.W. 2194



HINCHLIFFE MODELS LTD

MELTHAM, HUDDERSFIELD, ENGLAND HD7 3NX

Mar 81

NEW!

15mm Russian Napoleonic Cavalry 15mm Prussian & Austrians

(14p each)

C15/34 Dragoon Trooper
C15/35 Dragoon Officer
C15/36 Cuirassier Trooper
C15/37 Cuirassier Officer
C15/38 Hussar Trooper
C15/39 Hussar Officer

C15/40 Uhlan
C15/41 Uhlan Officer
C15/42 Cossack
C15/43 Cossack in Peaked Cap, charging
C15/44 Line Colonel

To follow shortly.

Bits & Pieces 25mm Releases.

American Civil War (ACWC) 20p each.
ACWC 14 Rushes Lancer Trooper MH5
ACWC 15 Rushes Lancer Officer MH5

Russian Napoleonic (RN) 20p each.
RN35 Russian Grenadier Advancing

25mm Equipment 25/
25/CH Russian Napoleonic Ammunition Case £1.00.

25/BR Pontoon bridge of sawn timber, comprising: 3 pontoon boats 3 road sections, 2 end ramps, and all necessary handrails. Approx. length 271mm, 50mm wide. £6.00.

25/BS Pontoon bridge addition kit, each kit adds approx. 75mm length to bridge 25/BR. Comprises: 2 pontoon boats, 2 road sections and all necessary handrails £3.36.

Foremost
FH6 Dragoon Horse standing with saddle and equipment. 30p.

Remember! - 20/21 British colonial baggage wagon is suitable for use with any period as a small wagon £2.00.



The Hinchliffe X Figure Range *The Highland Scots are here!*

We have long held stocks of figures that are the work of different designers than that of our main designer Peter Gilder.

In line with our policy of constant change and improvement we have decided to release some of these at regular intervals and these and associated equipment pieces will be known as our eX range.

Ex is the prefix of course for excellent, exceptional, extraordinary, excelsior and many other adjectives and all provide a fitting description to this new and exciting range of the 80's.

Although the work of many different designers will be a feature of this new and exciting range (another suitable adjective!) list effort has been made to keep the identity of the various designs that will be introduced. All will be compatible to each other and to the existing Hinchliffe Ranges which will still be available and be added to as before; we simply open up yet another dimension to the discerning wargamer.

Continuing further our idea of years ago to give separate weapons, standards etc. to our figures this will be enlarged upon in the new series to an even further degree and will include choice of accessories where relevant.

All figures, horses and equipment pieces will simply bear the prefix X followed by a number and be protected as always by the registered Hinchliffe Copy-right.

Scots of the English Civil War Period 20p per figure. 25p per horse. AVAILABLE NOW.

- X1 Highland piper, marching playing pipes with targe shield and claymore (S)
- X2 Highland archer shooting arrow with targe shield and claymore (S)
- X3 Highlander standing firing musket with claymore (S)
- X4 Highlander advancing with pike or claymore, with shield (S)
- X5 Highlander at rest, with pike, musket or rammer (S)
- X6 Highlander charging with shield and claymore (S)

- X7 Highland Chieftain on foot with claymore and shield (S)
- X8 Highland Gunner (or Pikeman) with portfire or pike and claymore (S)
- X9 Mounted lowlander, firing musket, with shield and claymore (S) (X12)
- X10 Mounted highlander holding lance with claymore and shield (S) (X12)
- X11 Mounted chieftain with claymore and shield (S) (X12)
- X12 Highland horse

All prices are stated until superseded by a new list and will be the same per item as those similar pieces listed under the Hinchliffe range.

- X13 Lowlander holding pike at present or ramming gun, with claymore (S)
- X14 Lowland musketeer (S) Denotes separate weapon(s) standards(s), drum etc.
- (X) Followed by a number(s) in bracket denotes a suitable horse(s) for that particular rider.
- (OPC) Denotes that the model is a one piece casting, e.g. horse and rider, pair of figures, cannon etc.



Special Offer

ROBIN HOOD BOARD Adventure Game

Contents: - 1 game board in 4 parts, 1 dice, instructions, 15 metal character figures.

A FUN GAME THAT CAN BE ADDED TOO FROM THE CALDER CRAFT ROBIN HOOD RANGE.

SALE PRICE ONLY £5.00

Next New Releases: MOUNTED SAMURAI 120mm SCALE (APPROX)

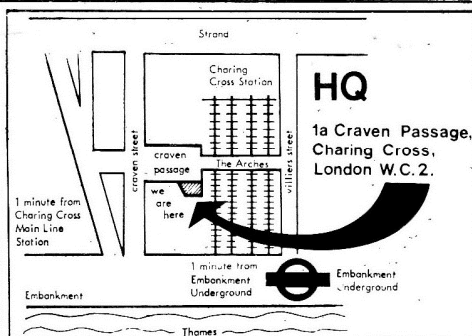

WHEN IN LONDON THIS MONTH CALL IN AND SEE OUR FULL RANGE OF MODELS! PLUS ALL OUR UP-TO-DATE RELEASES.

SEND TODAY FOR OUR FULL PRICE LIST 30p plus 12p p&p.

HINCHLIFFE HANDBOOK £3.00 plus 50p p&p.
HOBBY SPRAY WHITE PRIMER & MATT VARNISH 6oz. can 80p plus 14p p&p.

Visit our shop premises that open all week 9am-5pm and Saturday mornings

Direct Mail order post free over £12. 10% under £12

Full range of Davco tanks also available



U.S.A. HINCHLIFFE MODELS INC. 4824 MEMPHIS STREET, DALLAS, TEXAS 75207
AUSTRALIA: BATTLEFIELD, CLISSOLD PARADE, CAMPSIE, N.S.W. 2194

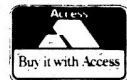



HINCHLIFFE MODELS LTD

MELTHAM, HUDDERSFIELD, ENGLAND HD7 3NX. TEL.: 0484 850654.

Apr 81

NEW

25mm ROMAN AND ANCIENT BRITISH RELEASES!

ANCIENT ROMAN (AR) 20p each

REMAKES

- AR9 ARTILLERYMAN
- AR10 ARTILLERYMAN WITH STONE PROJECTILE
- AR11 ARTILLERYMAN WITH DART

NEW RELEASES

- AR31 AUXILIARY INFANTRY ATTACKING
- AR32 AUXILIARY INFANTRY SLINGER
- AR33 AUXILIARY INFANTRY ARCHER
- AR34 LEGIONARY ATTACKING

EQUIPMENT GROUP (EG) £2.00 each

- EG45 ANCIENT BRITISH CHARIOT
- EG46 BOUDICCA'S CHARIOT
- EG47 CHIEFTAINS CHARIOT

ANCIENT BRITISH (AB) 20p each

REMAKES

- AB1 BRITISH SLINGER
- AB3 BRITISH INFANTRY WITH JAVELIN
- AB4 INFANTRY WITH SWORD AND SHIELD

NEW RELEASES

- AB2 CHIEFTAIN, ON FOOT
- AB5 SLINGER
- AB6 FOOT WARRIOR CHARGING
- AB7 FOOT WARRIOR
- AB8 WARRIOR RUNNING BY CHARIOT

PERSONALITY FIGURE (PF) 56p each

- PF35 JULIUS CAESAR

HORSES (MH) 25p.

- MH12 RENAISSANCE FULL PLATE ARMOUR, HORSE GALLOPING

SPECIAL ARMY OFFER ONLY £26.00 post free
Ideal for beginner or experienced alike – a chance to obtain our new releases in an army at a special discounted price.

Ancient Roman Army consisting of Julius Caesar – 3 cohorts infantry – cavalry cohort – catapult and crew. 133 figures and equipment in total.

Ancient British Army consisting of Boudicca's chariot plus five other chariots, 10 cavalry, 18 slingers and 48 mixed foot warriors.

EACH ARMY WOULD NORMALLY COST **£30.00** PLUS. WE ARE OFFERING YOU EITHER ARMY AT A **SPECIAL OFFER PRICE OF £26.00 POST FREE**. OFFER ENDS THURSDAY 30th APRIL, 1981.

LARGER SCALE FIGURINES – SUPERBLY DETAILED AND READY FOR IMMEDIATE DELIVERY – ALL POST FREE UNTIL APRIL 30th.

80mm



PARACHUTE REGT. PRIVATE ARNHEN
1944 £6.50

80mm Figures (80/1) £6.50

- 8001 American Civil War Zouave Sergeant 14th New York
- 8002 Wounded Confederate Soldier
- 8003 Grenadier 12th foot (Suffolk regt.) 1759
- 8004 Officer of the Cameron Highlanders Tel-El Kebir 1882
- 8005 Parachute Regt. private Arnhem 1944
- 8006 Corporal 1st Royal Dragoons, Waterloo period
- 8007 13th century Mounted Knight **£22.00**
- 8008 17th Lancer Light Brigade Charge, Crimea Period
- 8009 Byzantine Warrior, 11th Century
- 8010 Baylors Dragoon Officer 1778

90mm Figures (90) £8.15

- 90/1 Prussian Grenadier 1812
- 90/2 Prussian Landwehr Infantry 1814
- 90/3 Cleve-Burg Infantry Officer 1812
- 90/DJ1 Highland Private 42nd Regt. Waterloo
- 90/DJ2 Young Guard Traillleur, Grenadier 1809
- 90/DJ3 Officer, 9th Lancers, Circa 1820
- 90/DJ4 RHA Troop Artillery Captain Peninsular/Waterloo Period
- 90/DJ5 Officer of the Light Company 33rd Regt. of Foot (West Riding 1815)
- 90/DJ6 Life Guards Trooper 1815
- 90/DJ7 British Officer 7th Hussar 1808

NEXT MONTH!

90mm (plus) Figurine "Old Guard at Bay" - by a well known American Designer.

80mm



MODEL CODE 8007
13th CENTURY MOUNTED KNIGHT £22.00

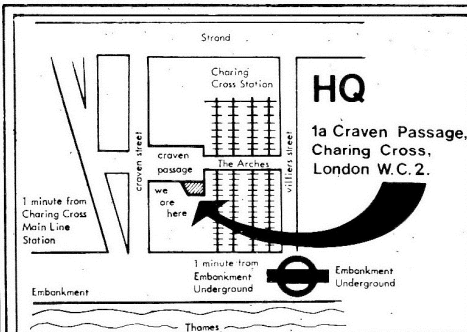

WHEN IN LONDON THIS MONTH CALL IN AND SEE OUR FULL RANGE OF MODELS! PLUS ALL OUR UP-TO-DATE RELEASES.

SEND S.A.E. FOR YOUR NORTHERN MILITAIRE PAINTING COMPETITION RULES AND BE PREPARED TO WIN.

SEND TODAY FOR OUR FULL PRICE LIST 30p plus 12p p&p.

HINCHLIFFE HANDBOOK £3.00 plus 50p p&p.
 HOBBY SPRAY WHITE PRIMER & MATT VARNISH 6oz. can 75p plus 14p p&p.

Visit our on the premises shop open all week 9am-5pm and Saturday mornings
 Direct Mail order post free over £12. 10% under £12
 Full range of Davco tanks also available
 worth a call if you're passing.

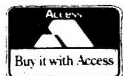

U.S.A. HINCHLIFFE MODELS INC. 4824 MEMPHIS STREET, DALLAS, TEXAS 75207
AUSTRALIA: BATTLEFIELD, CLISSOLD PARADE, CAMPSIE, N.S.W. 2194



HINCHLIFFE MODELS LTD

21 STATION STREET, MELTHAM, HUDDERSFIELD. TEL.: 0484 850654.

May 81

CALDER CRAFT NEW RELEASE - MOUNTED SAMURAI

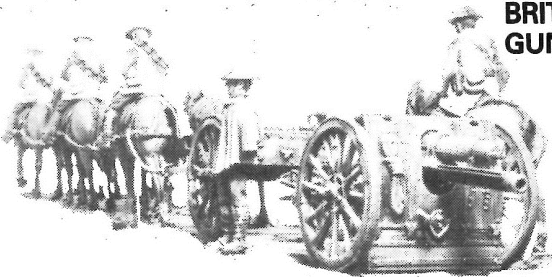

BRITISH WORLD WAR I GUN TEAM. Code 5404 ONLY £42.84

We gave you the Gothic knight in 1980 - we called it the model of the year reviewers called it the model of the decade - what are they going to say about this one?

In your shops now or direct £65 incl. VAT. A great addition to our world famous foot TAISHO (RLO/1) Now on horseback and much easier to assemble. Pictures next month. Model Code PKO/3.

AVAILABLE NOW FROM YOUR CALDER CRAFT DEALER 1/32 SCALE HORSE TEAMS & ARTILLERY DIORAMAS

- | | | | |
|---|--------|---|--------|
| 5401 French Horse Artillery of the Guard Crew and 8 pdr gun | £18.00 | 5406 German II World War Gun Team, horses, crew and officer | £62.84 |
| 5402 British Napoleonic horse, artillery crew and 6 pdr gun | £18.00 | 5407 French Napoleonic Galloping Gun Team | £35.20 |
| 5403 French Napoleonic Larrey light ambulance horses and attendants | £25.46 | 5408 French Napoleonic Field Forge on Campaign | £25.46 |
| 5404 British World War I Gun Team, horses, crew and officer | £42.84 | PKO/1 Gothic Knight | £31.90 |
| 5405 British Napoleonic Gun Team, horses, crew and officer | £42.84 | RLO/1 Samurai Warrior | £22.00 |
- Send S.A.E. for list.

NEW 25mm ADDITIONS

X-RANGE EUROPEAN MEDIEVAL

- X17 English Pikeman 16th century (S)
- X18 English Longbowman 16th century (S)
- X19 Mounted German Standard Bearer or Knight (OPC) (S)
- X20 Henry VIII on Horse Back after Holbien (OPC)
- X22 English Man at Arms (S)
- X23 Spanish Pikeman 16th century
- X24 French Mounted Crusader 13th century (S) (X21) (X12)
- X25 Mounted Stradiot (S) (X21) (X12)
- X26 Mounted Knight circa 1360 (S) (X27)
- X28 English Foot Knight

Yet more exceptional figures to swell the ranks. Only 20p each.

EQUIPMENT GROUPS (EG)

- EG27 Renaissance Triple Organ Gun with Marker Flag Powder and Shot Trailer, 2 Horses in Tandem (Driver on Lead Horse), 4 Gunners in Attendance.
- EG28 Renaissance Three Barrelled Cannon with Marker Flag Powder and Shot Trailer, 2 Horses in Tandem (Driver on Lead Horse), 4 Gunners in Attendance.
- EG29 Renaissance Single Bank Organ Gun with Two Horse Team in Tandem (Driver on Lead Horse), Marker Flag, Powder and Shot Trailer, 4 Gunners in Attendance.

NORTHERN MILITAIRE '81

We have a new venue for Northern Militaire '81. This year we have much more space and would therefore like to invite the following people to make this new Oldham venue one to remember.

- Clubs and societies if you offered you space could you use it to everyone's advantage?
 - Trade stands more space means more trade can attend - why not put your name on the list.
 - Painting competition rules now available.
- Write now and see what we can offer!

GLOOM & DESPONDANCY!

- not in this company, stuff is just fighting to get out of our door. In the works ready for release - A Renaissance 54mm Falconet Cannon 54mm Landsknechts Vignette and Singles Napoleonic for the Hinchliffe 25mm Range - many figures going into winter gear - very paintable very playable.



75/JB15 LONGBOWMAN - 1st CRUSADE



75/JB23 HAND GUNNER EARLY RENAISSANCE PERIOD



75/JB13 LANDSKNECHT 1553



U.S.A. HINCHLIFFE MODELS INC. 4824 MEMPHIS STREET, DALLAS, TEXAS 75207 AUSTRALIA: BATTLEFIELD, CLISSOLD PARADE, CAMPSIE, N.S.W. 2194

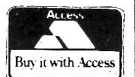

The Mounted Samurai

CALDER CRAFT

A DIVISION OF HINCHLIFFE MODELS LTD
21 STATION STREET, MELTHAM,
HUDDERSFIELD HD7 3NX.

Jun 81

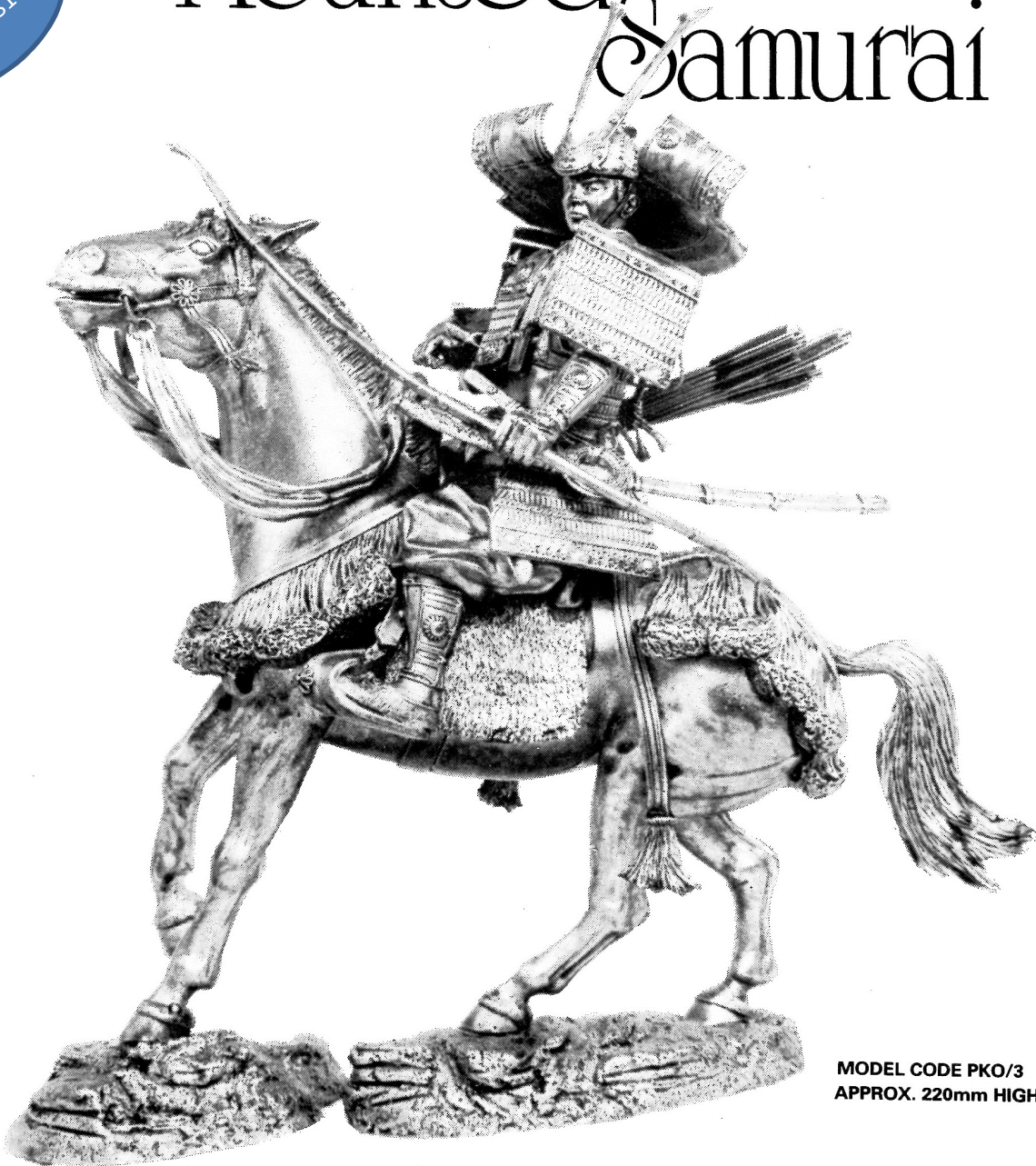

MODEL CODE PKO/3
APPROX. 220mm HIGH

In 1980 the Gothic Knight, remember?

We called it the model of the year, the reviewers the model of the decade.

What will be said of this one. Surely a must for every serious collector or the fantasy gamer who must have the world's best General!

A mounted version of our renowned Samurai on foot the famous RLO/1 but with many new features to strengthen and aid assembly – full instructions and colour plates with each kit. £65 incl. VAT. At your retailers now or write direct.

FROM HINCHLIFFE NEXT MONTH

More 25mm Napoleonics in Winter Campaign Dress. A new 54mm Gun Kit. 54mm Landsknechts – Vignettes and Singles.



HINCHLIFFE MODELS LTD

21 STATION STREET; MELTHAM, HUDDERSFIELD. TEL.: 0484 850654.

AUG 81

54mm LANDSKNECHTS

A SUPERB RANGE OF FINELY
SCULPTED FIGURINES

Single figures £3.20 each
F77 Landsknechts Drummer
F78 Landsknecht sitting on rock holding pike
F79 Landsknecht Sulteress
F80 Landsknecht with bear stein
F81 Landsknecht with double-handed sword over shoulder
F82 Landsknecht Gunner pulling gun
F83 Landsknecht Gunner pushing gun

Vignette £5.20 each
54/V6 Landsknecht pikeman and drummer sharing the loot
54/V7 Landsknecht — wayside refreshment
54/V8 Landsknecht gunners £9.00
ME/G/27 Renaissance Falconet £3.96

MORE NEXT MONTH!

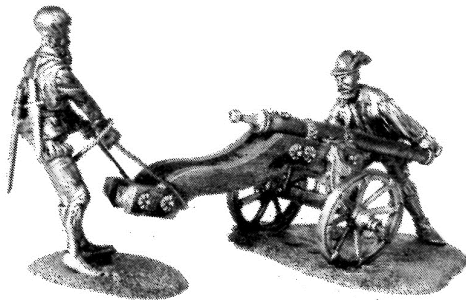

DIRECT MAIL ORDER SPECIALISTS

Our full range of models and accessories always in stock. Prompt delivery — Samples sent on request (small charge) — Order either by post or telephone (credit cards only) — Payment with order (cheque, credit card or postal order) — Overseas deliveries no problem (Giro payment preferred). Don't forget our on the premises shop open 9-5, 5 days a week plus 9-12.30 Saturday mornings. Send S.A.E. for our special sample and club discount sheet.

HINCHLIFFE
HANDBOOK
£5.00 plus P&P.
60p U.K.
90p Overseas.

PRICE LIST
30p plus 11p P&P
Hobby spray-
varnish or
primer 80p/6oz
can

Valiant Miniatures®



90mm Figure
9831 Rommel £6.50

54mm Collectors Figures
9720 WWII German SS mounted cavalryman £6.70
9728 31st Mountain Artillery Battery Gunner, India £3.20
9729 British Officer, 27th light cavalry, Indian Army £3.20
9731 Niak, 101st Grenadiers, Indian Army £3.20
9801 Wyatt Earp £3.20
9802 Doc. Holliday £3.20
9803 Geronimo £3.20
9732 French line infantryman 1813 £3.20
9734 Russo-German Jaeger 1913 £3.20
* 9753 Nordic Barbarian Warrior £3.20

ONCE AGAIN THIS RENOWNED RANGE IS
AVAILABLE TO THE EUROPEAN MARKET-
EXCLUSIVE TO US - WRITE FOR THE COM-
plete LIST OR WATCH OR ADVERTS FOR
THEIR LATEST AND BEST.

£1.20 per pack

stardate : 3000™

NUMBER IN BRACKETS
DENOTES No. PER PACK

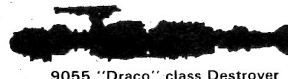

9055 "Draco" class Destroyer



9056 "Aries" class Escort Cruiser

9050 Intruder IID Scout (9)
9051 Vigilante IIC Interceptor
9052 'Phantom' VB Assault ship (4)
9053 Alien Banshee Scout (6)
9054 Alien Vampire Interceptor (4)
9055 Draco Class Destroyer (2)
9056 Aries Class Escort Cruiser (1)
9057 Perseus Class Cruiser (1)
9063 Small movement stands (9)
9064 Large movement stands (6)

1/200 Scale Sailing Men o'War £1.20 per pack

Fighting Sailor®



9000
100 Gun Ship of the Line



9001
74 Gun Ship of the Line



9002
44 Gun Frigate

NUMBER IN BRACKETS
DENOTES No. PER PACK

9000 100 gun ship of the line (2)
9001 74 gun ship of the line (2)
9002 44 gun frigate (2)
9003 36 gun frigate (2)
9004 20 gun sloop of war (3)
9005 18 gun Brig of war (3)
9006 16 gun Schooner (3)

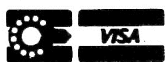

U.S.A. HINCHLIFFE MODELS INC. 4824 MEMPHIS STREET, DALLAS, TEXAS 75207
AUSTRALIA: BATTLEFIELD, CLISSOLD PARADE, CAMPSIE, N.S.W. 2194



Prices quoted are those prevailing at press date and are subject to alteration due to economic conditions



HINCHLIFFE MODELS LTD

21 STATION STREET, MELTHAM, HUDDERSFIELD. TEL.: 0484 850654.

"NELSON & HARDY" in 100mm

Nov 81



Sculptured by Mike Tapavica

If you saw September's issue of *Military Modelling* then you know of Mike Tapavica.

An informed impressive sculptor and painter is how he's described. The proof is in our latest issue from Mike — it's 100mm and it's my favourite Admiral and his loyal Captain.

... It's October 21st, 1805 and the Vignette says it all.

MTO/1&2 Shortly available in separate pieces.

MTO/1 Nelson 1805

MTO/2 Captain Hardy 1805

Also by Mike Tapavica "Old Guard at Bay" Now at £9.50. From the same sculptor a new 100mm mounted piece — watch our adverts.

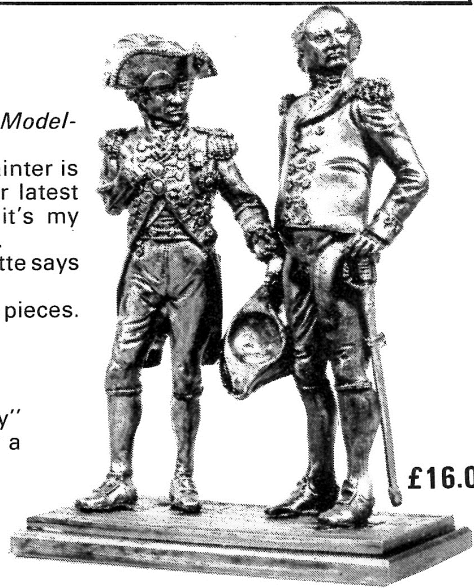

£16.00

"OLD GUARD AT BAY"

CALDER CRAFT

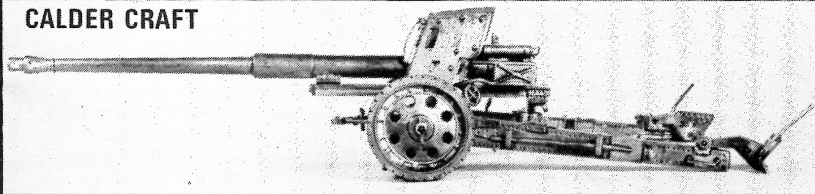

NEW! GERMAN WORLD WAR II 8.8cm PAK 43/41 ANTI-TANK GUN

Another super model gun in cast metal from our extensive range of 1:32nd equipment models. Probably the first time this model has been available in metal or plastic.

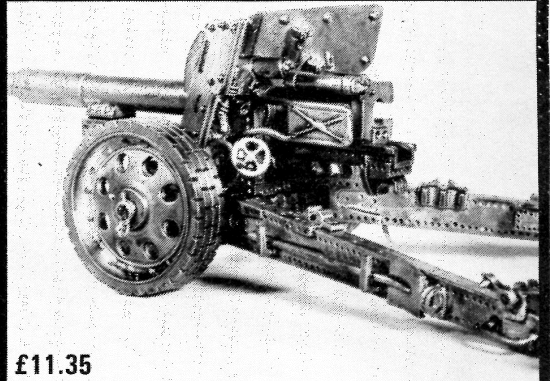

£11.35

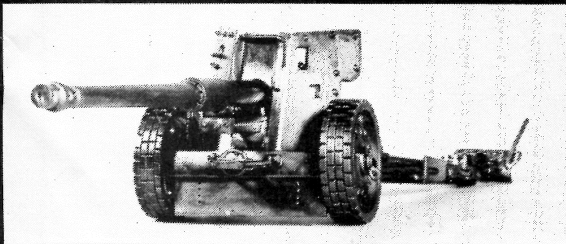

Valiant Miniatures

NEW RELEASES!
VALIANT 54mm — £3.20

- 9704 German Panzer Corp. Army Sergeant 1940
- 9708 Viking
- 9710 U.S.M.C. Marshall Islands 1944
- 9711 WWII Japanese Infantryman
- 9712 El Cid

stardate: 3000™

Fighting Sail!

1:2000 Scale Men-o'-War
Send for full list today

DIRECT MAIL ORDER SPECIALISTS

Our full range of models and accessories always in stock — prompt delivery — samples on request half price for any 25mm figure to a maximum of 10 figures (one of each type only) sent post free. Order either by post or telephone (credit cards only) — Payment with order (cheque, credit card or postal order) — Overseas deliveries no problem, (Giro payment preferred). Don't forget our on the premises shop open 9.00 a.m.-5.00 p.m., 5 days a week plus 9.00 a.m.-12.30 p.m. Saturday morning. Send S.A.E. for our latest samples and club discount sheet.



U.S.A. HINCHLIFFE MODELS INC. 4824 MEMPHIS STREET, DALLAS, TEXAS 75207
AUSTRALIA: BATTLEFIELD, CLISSOLD PARADE, CAMPSIE, N.S.W. 2194



KINDLY MENTION "MILITARY MODELLING" WHEN REPLYING TO ADVERTISEMENTS

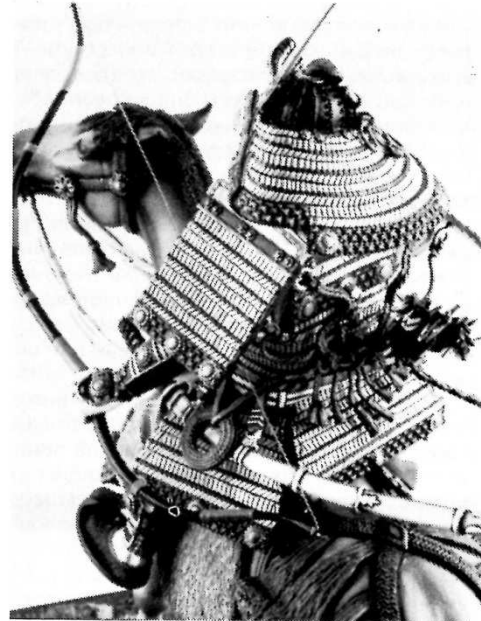



HINCHLIFFE MODELS LTD

21 STATION STREET, MELTHAM, HUDDERSFIELD. TEL.: 0484 850654.



Happy Christmas!

Can we take this opportunity to wish all our customers and readers a Happy Christmas and a Happy and prosperous New Year.

Despite our present economical climate you will see from the following that we're doing our best at the Fun Factory to help make it so, chisels are sharpened and pots are bubbling and we're all poised to make 1982 a year to be remembered if only for our outpourings of figures.

ROBIN HOOD

Heard of our Robin Hood range of goodies? Whether yes or no they're listed below and are now available as singles or vast collections at the prices listed. Did you know there is quite a Medieval range lurking among them, you didn't? Just read the list.

FIGURES 20p (OPC) ONE-PIECE CASTING 45p

SEE US ON STAND No. 92
AT THE 51st
MODEL ENGINEER EXHIBITION
WEMBLEY CONFERENCE CENTRE



FOOT

- RH1 Robin Hood
- RH2 Little John
- RH3 Friar Tuck
- RH4 Will Scarlet
- RH5 Alan a Dale
- RH6 Mutch the Millers Son
- RH7 Man at arms with spear and shield
- RH8 Maid Marion
- RH9 Follower of Robin Hood — running
- RH10 Follower of Robin Hood — with sword
- RH11 Follower of Robin Hood — firing bow
- RH12 Villager woman with a child
- RH13 Outlaw with sword attacking
- RH14 Villager with sack over shoulder
- RH15 Villager boy and girl
- RH16 Villager with dog
- RH17 Man at arms charging with halbard
- RH18 Man at arms with crossbow
- RH19 Sergeant man at arms
- RH20 The collector in chair
- RH21 Villager with money bag
- RH22 Robin Hood in cloak, firing bow
- RH23 John the Bowman firing bow
- RH24 Robin Hood with quarter staff
- RH25 Little John with quarter staff
- RH26 Man-at-Arms marching with sword

CAVALRY

- RHC1 Prince John on horseback (OPC)
- RHC2 Sheriff of Nottingham on horseback (OPC)
- RHC3 Sir Guy of Gisborne on horseback (OPC)
- RHC4 Mounted man at arms (OPC)
- RHC5 Mounted sergeant at arms (OPC)
- EG48 Baggage cart with solid wooden wheels and sides with horse £2.00

ROBIN HOOD BOARD
GAME & FIGURES £6.00

DARK AGES

NEW
25mm

Does the name Peter Gilder ring a bell — good! Then you must know that he is responsible as ever for the design of our 25mm figures including most of the Fantasy and all of the Foremost — we lost him for a month or two while he Wargame Holidayed (twice the success of last year!) we're back to normal, so read the list of the first issue of our Dark Ages Range, available now and more to come. I am determined to have my castle-storming parties before long! First releases will be on sale on our Stand at the Model Engineer Exhibition. A full list of our first releases in next months ad.

Now for a pot pourri of what should have been listed before, but somehow lost their way North of St. Albans — take a grip of yourselves and read on!

- 20mm — 19p each
- A6 American Infantry in Greatcoat
- A7 American Infantry in Greatcoat with Rifle.
- 20mm EQUIPMENT
- 20/31 German WWII 15cm Heavy Infantry Gun — £2.00. **NEW!**
- 25mm ONE PIECE CASTINGS (56p ea)
- OPC25 Wellington
- OPC28 Napoleon

- OPC80 Czar Alexander
- OPC31 Field Marshall Blucher
- 25mm INFANTRY — 20p each
- BN50 Ensign with Kings Colours (OPC)
- BN59 Ensign with Regimental Col. (OPC)
- BN69 Highlander with Kings Colour (OPC)
- BN70 Highlander with Kings Colour (OPC)
- BN71 Fusilier Ensign with Kings Col. (OPC)

- BN72 Fusilier Ensign with Regimental Colour (OPC)

- FANTASY (FA)
- Fa82 Old Witch — 28p.

- FN44 Line Infantry Standard Bearer (OPC)
- FN54 Old Guard Standard Bearer (OPC)

X-RANGE: American War of Independence

You must know of our X-range of figures set up to accommodate designers other than Peter — I knew you would have — well we're adding a new designer to the list, Steve Hizzlewood. We offer no excuse for another American War of Independence range other than they are truly Continental and above all are the finest figures available today *but* they are actually miniature men with realistic poses and true proportions, could be too much for some people — we've had them around for a year or two, but we really mean a Happy New Year for the more discerning. A full listing below, those asterisked are available now, other releases over the next month or two.

BRITISH, CONTINENTAL, HESSIAN OR FRENCH *NOW AVAILABLE — 20p EACH

- *X33 Batt. Company Private at Attention.
- *X34 Line Officer at Attention.
- BRITISH**
- *X35 Drummer Boy at Attention.
- *X36 Grenadier at Attention.
- *X37 Light Company Private Advancing.
- *X38 Grenadier Company Officer at Attention.
- *X39 Mounted Light Dragoon (Horse x48)

- HESSIAN**
- X40 Grenadier at Attention.
- CONTINENTAL**
- *X41 Drummer Boy Advancing.
- *X42 Corps of Light Infantry Private Advancing.
- *X43 Militiaman in Shirt Advancing.
- *X44 Militiaman in Coat Advancing.
- *X45 Marine Advancing.
- *X46 Rifleman at the Ready.
- *X47 Mounted Light Dragoon (Horse x48)

- HORSES**
- *X48 Troop Horse.
- *X49 Officer's Mount.
- X50 Limber Horse.
- GENERAL FIGURES**
- X51 Gunner Standing.
- X52 Male Civilian Standing.
- X53 Female Civilian Standing.
- *X54 Mounted General Officer (Horse x49)

- X55 Seated Civilian Rider (Horse x50)
- X56 Indian Advancing.
- X57 Seaman in Shirt Advancing.
- X58 Seaman Bare-chested Standing.
- X59 Seaman in Shirt Kneeling.

- AVAILABLE EQUIPMENT:**
- Naval Cannon 25/AA, Gun Limber 25/AP, 8-pdr. Gun 25/B, 12-pdr. gun 25/C and Galloper Gun 25/BA.

Note: some will have separate weapons and X33 and X34 should be used for British Continental, French or Hessian line troops, the difference is so small the paint job does it, same applies to the artillery crew officers, just use X. Will explain about the artillery when we've some more room!

TOP SECRET — he's doing us a Samurai range, Renaissance period, for release early '82.

Doesn't leave us much room now, but we have six new 54mm Gunner WWII crew men for our not yet surpassed field piece 150mm field howitzer 8.8mm PAK. Isn't it odd how they're all at it in the hobby now, but only the giant Tamiya have come up alongside us with the real technical stuff — gun kits just like we do. Odd when there are so many ravers in our hobby today, I digress, here are the gunners:

54mm Figures — £3.20

- F84 German WWII Gunner Officer — Peaked Cap
- F85 German WWII Gunner Crouching with Shell
- F86 German WWII Gunner Standing arm raised looking at watch
- F87 German WWII Gunner leaning to pull lanyard
- F88 German WWII Gunner kneeling to gun

54mm Cavalry

- 54/C11 Landsknecht Standard Bearer — £5.20

Just for closures how about our 54mm mounted Landsknecht Standard Bearer. C11 Price £5.20, designed by Paul Knight who gave you the Gothic Knight and the whopping mounted Samurai.

That reminds me, we do want to make it a Happy Christmas and New Year, so we're lowering the price of the **MOUNTED SAMURAI PKO/3 TO £55** for a period up to 1st February.

Thanks to all who made Northern Militaire a success, we were bound to make a few mistakes at our new venue — what few there were the two Johns' will sort out in 1982 — we're making it a Happier New Year all the time!



U.S.A. HINCHLIFFE MODELS INC. 4824 MEMPHIS STREET, DALLAS, TEXAS 75207
AUSTRALIA: BATTLEFIELD, CLISSOLD PARADE, CAMPSIE, N.S.W. 2194





HINCHLIFFE MODELS LTD

21 STATION STREET, MELTHAM, HUDDERSFIELD. TEL.: 0484 850654.

Jun 82

DARK AGES 25mm scale

INFANTRY

- DA2 Norman heavy infantry standing.
- DA3 Norman heavy infantry attacking.
- DA5 Norman archer.
- DA8 Saxon heavy spearman.
- DA9 Saxon Fyrd spearman (med.)
- DA10 Saxon javelinman.
- DA11 Saxon Husecarl with double-handed sword.

DAC2 Norman knight attacking.

CAVALRY

DAC2 Norman knight attacking.

Please note our new prices.

25mm Figures **22p**

Horses **28p**

15mm Figures **9p**

Cavalry **18p**

CALDER CRAFT boxed kits at

PKO/3 Mounted Samurai..... **£55.00**

RLO/1 Foot Samurai..... **£22.00**

PKO/1 Gothic Knight..... **£28.00**

PKO/2 Private 24th Foot..... **£16.00**

Prices all post free if you send direct



8009 Byzantine warrior 11th century £7.15



8007 13th century mounted knight £22.00

Send today for our up-to-date range kit. 30p plus 12½p post. Hinchliffe Handbook, £5.00 plus 65p p&p.



HINCHLIFFE MODELS LTD

21 STATION STREET, MELTHAM, HUDDERSFIELD. TEL.: 0484 850654.

Jul 82

NEW RELEASE!

BRITISH NAPOLEONIC INFANTRY (BN) 25mm 22p FOOT & CAVALRY 28p HORSE
BN75 LINE INFANTRY IN GREATCOAT STANDING FIRING

CAVALRY (BNC)

- BNC32 SCOTS GREY IN CAPE
- BNC33 HUSSAR IN CAPE
- BNC34 DRAGOON STANDARD BEARER IN CAPE
- BNC35 HOUSEHOLD CAVALRY STANDARD BEARER IN CAPE
- BNC36 HUSSAR STANDARD BEARER IN CAPE
- BNC37 SCOTS GREY STANDARD BEARER IN CAPE

FRENCH NAPOLEONIC

CAVALRY (FNC)

- FNC53 CUIRASSIER IN CLOAK
- FNC58 CARABINIER IN CLOAK
- FNC62 HUSSAR IN CLOAK
- FNC66 EMPRESS DRAGOON IN CLOAK

"IN THE GRAND MANNER"
NAPOLEONIC RULES BY PETER GILDER **£3.00**

HINCHLIFFE BEGINNERS GUIDE TO WARGAMING 50p

HINCHLIFFE HANDBOOK £5.00
FULL PRICE LIST 35p

D.M.O. — U.K.

10% P&P UNDER £15.00 OVER POST FREE
DON'T FORGET — OUR ON THE PREMISES RETAIL SHOP OPEN.

Office Hours: Mon.-Fri. & Sat. mornings to 12.30 p.m.

NEXT MONTH'S RELEASE! 25mm SAMURAI

54mm German WWII 10.5cm LFH 18m Field Gun

NORTHERN MILITAIRE '82

OLDHAM CIVIC HALL, NOVEMBER 6th & 7th.
PAINTING COMPETITION RULES NOW AVAILABLE. SEND S.A.E.

TRADE ENQUIRIES TO ABOVE ADDRESS

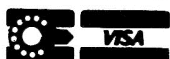

U.S.A. HINCHLIFFE MODELS INC. P.O. Box 7307, DALLAS, 75207, TEXAS
AUSTRALIA: BATTLEFIELD, CLISSOLD PARADE, CAMPSIE, N.S.W. 2194





HINCHLIFFE MODELS LTD

21 STATION STREET, MELTHAM, HUDDERSFIELD. TEL.: 0484 850654.

Aug 82

BACKBONE OF THE GERMAN ARMY

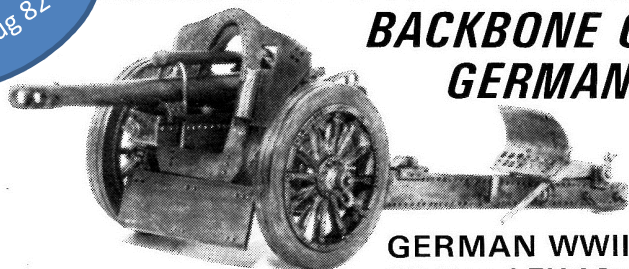

GERMAN WWII
10.5cm LFH 18m FIELD GUN

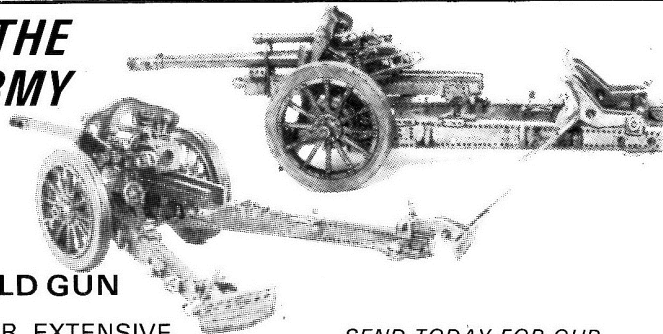

NEW!

THIS LATEST ADDITION TO OUR EXTENSIVE RANGE OF ARTILLERY PIECES IN 1/32nd SCALE IS NOW AVAILABLE **£12.50**

SEND TODAY FOR OUR UP-TO-DATE PRICE LIST 35p PLUS 12½p POSTAGE.

NEXT MONTH
25mm
SAMURAI
PLUS OTHER 25mm
FIGURES



DON'T FORGET, IF YOU'RE PASSING, OUR FACTORY SHOP IS WELL WORTH A VISIT—OPEN OFFICE HOURS, WEEKDAYS & SAT. MORNINGS

NORTHERN MILITAIRE '82 OLDHAM CIVIC HALL
NOVEMBER 6th & 7th. IF YOUR CLUB OR SOCIETY HAS SOMETHING IT WOULD LIKE TO SHOW OR EXHIBIT — PLEASE GET IN TOUCH.
PAINTING COMP. RULES NOW AVAILABLE — SEND S.A.E.



U.S.A. HINCHLIFFE MODELS INC. P.O. Box 7307, DALLAS, 75207, TEXAS
AUSTRALIA: BATTLEFIELD, CLISSOLD PARADE, CAMPSIE, N.S.W. 2194

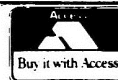

HINCHLIFFE MODELS LTD.

21 STATION STREET, MELTHAM, HUDDERSFIELD.
TELEPHONE: 0484 850654

Nov 82



MOUNTED KNIGHT CIRCA EARLY 16th cent.

MODEL CODE:
MTO/3
£28.00

SEE US ON STAND No. 92 MODEL ENGINEER EXHIBITION '83.

LARGE SCALE FIGURES:

8007 17th Lancer Crimea	£22.00	
8008 13th Century Mounted Knight	£22.00	
RLO/1 Foot Samurai	£22.00	
PKO/1 Gothic Knight	£28.00	
PKO/2 Private 24th Foot	£16.00	
PKO/3 Mounted Samurai	£55.00	
75mm Foot	£5.90	
75mm Cavalry	£16.00	
80mm Foot	£7.15	See list for range details
90mm Foot	£8.80	

BOXED KITS (Calder Craft)

5401 French Horse Artillery Gun & Crew (54mm)	£17.50
5402 British Napoleonic Artillery Gun & Crew (54mm)	£17.50
5403 French Napoleonic Larrey Ambulance & Crew (54mm)	£28.00
5404 British WWI Gun Team (54mm)	£42.84
5405 British Napoleonic Gun Team (54mm)	£42.84
5406 German WWII 8-Horse Team	£50.00
5407 French Napoleonic Galloping Team	£35.20
5408 French Napoleonic Field Forge	£25.46

Full ranges of 25mm — 54mm — 75mm and other scales. All models easily available through our D.M.O. service. Send today for our full price listing: 30p plus 15p p&p. Hinchliffe Handbook & Painting Guide £5.00 plus 65p p&p.

Designed by:
MIKE TAPIVICA



SCALE:
100mm

THE MODEL STANDS 200mm HIGH — WITH A LANCE LENGTH 240mm
TELEPHONE & WRITTEN CREDIT CARD ORDERS WELCOME.



U.S.A. HINCHLIFFE MODELS INC. P.O. Box 7307, DALLAS, 75207, TEXAS
AUSTRALIA: BATTLEFIELD, CLISSOLD PARADE, CAMPSIE, N.S.W. 2194





Sep 83

HINCHLIFFE MODELS LTD.

21 STATION STREET, MELTHAM, HUDDERSFIELD, W. YORKS.
TELEPHONE: 0484 850654

FOR THE BEST IN WARGAME AND COLLECTORS FIGURES

RUSSIAN AND HORSE BASHKIR
1812-14

£17.45

Model Code
75/JBC7



NEW

1983 PRICE LIST — NOW AVAILABLE

Price 40p plus 15½p postage

15mm BRITISH/FRENCH/RUSSIAN
25mm NAPOLEONIC/A.C.W./E.C.W.
AMERICAN WAR OF INDEP./
7 YEARS WAR/ANCIENT/MEDIEVAL/
RENAISSANCE/FANTASY FIGURES FOR THE GAMER.

**CALDER CRAFT
MODEL KITS**
LARGE SCALE FIGURES FOR
THE COLLECTOR.
FULL LIST AVAILABLE.

**NORTHERN
MILITAIRE '83**
OLDHAM CIVIC HALL
5th & 6th NOVEMBER, 1983
IF YOU HAVE ANYTHING YOU WISH
TO DEMONSTRATE OR SHOW WE
MAY HAVE SPACE — PLEASE WRITE.

**INTER-CLUB
WARGAME COMP.
NORTHERN MIL. '83**

OUR INTER CLUB COMPETITION WILL SOON
BE UNDERWAY FOR 1983 — IF YOUR CLUB
WOULD LIKE TO ENTER. PLEASE SEND FOR
OUR ENTRY FORM.

DIRECT MAIL ORDER

Using your new price list, our D.M.O. Department will service all your orders home and overseas fast and efficiently. Payment with order or ring your order through using Visa/Access (office hours only 9-5). Postal Rates: Free for orders £15 and above please add 10% below this (UK). See list for overseas rates. HINCHLIFFE HANDBOOK £5.00 plus 95p post & packing.

SEE OUR PRICE LIST FOR OTHER LARGE SCALE MOUNTED FIGURES.



HINCHLIFFE MODELS LTD

21 STATION STREET, MELTHAM, HUDDERSFIELD. TEL.: 0484 850654.

Feb 84



8012



8011



8014

NEW WARGAME RELEASES

BRITISH COLONIAL
BC31 HADEMDOWAH WARRIOR, THREATENING
BC32 HADEMDOWAH WARRIOR, CHARGING
BC33 HADEMDOWAH WARRIOR, CROUCHING
BC34 HADEMDOWAH WARRIOR, THROWING SPEAR

AMERICAN WAR OF INDEPENDENCE
AW46 LINE INFANTRY ATTACKING

AMERICAN CIVIL WAR
ACW44 INFANTRY IN GREATCOAT
ACW45 OFFICER IN GREATCOAT
ACW46 DISMOUNTED CAVALRY OFFICER

ACWC17 MOUNTED OFFICER, LH3, LH4
ACWC18 GUN LIMBER RIDER, LEFT HAND
ACWC19 GUN LIMBER RIDER, RIGHT HAND
REMAKE OF FNC23 GRENADIER A CHEVAL OF THE
GUARD

80mm RELEASES

8011 CONTINENTAL MUSKETEER
8012 SOLDIER OF THE 80's
8013 2nd REGIMENT LANCER OF THE GUARD
8014 TRUMPETER, ELITE COY LINE DRAGOONS
8015 MUSICIAN, 15th LINE INFANTRY 1806
8016 OFFICER 6th DRAGOONS, 1806
8017 PRIVATE GRENADIER COMPANY 84th FOOT
(WALKING WOUNDED) 1808

AUSTRALIA: BATTLEFIELD, CLISSOLD
PARADE, CAMPSIDE, N.S.W. 2194

TO ALL OUR UNITED STATES CUSTOMERS
ALL OUR PRODUCTS ARE NOW AVAILABLE DIRECT FROM THE U.K. SEND NOW FOR OUR FULL LISTING — MANY ITEMS NEVER BEEN AVAILABLE IN THE STATES — INTERNATIONAL REPLY COUPON WILL SECURE IMMEDIATE RETURN.
U.K. QUALITY DIRECT TO YOU!



FAST EFFICIENT DIRECT MAIL ORDER SERVICE - SEND 40p PLUS 15p POSTAGE FOR FULL LISTING.

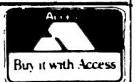



HINCHLIFFE MODELS LTD

21 STATION STREET, MELTHAM, HUDDERSFIELD. TEL.: 0484 850654.

Jul 84

1000'S OF
WARGAME FIGURES
STILL THE BEST
RANGE



FROM OUR
FAST EXPANDING
80mm RANGES



8021



MTO/4



75/JB29

- 8022 Voltigeur Drummer 96th Line Regt. Peninsular **£7.80**
 - 75/JB29 Lancer, Regt. St. Clement 1912 **£6.43**
 - MTO/4 Mounted Knight 16th Cent. **£24.00**
 - 8011 Continental Musketeer 17th Century **£7.80**
 - 8012 British Soldier of the 80's **£7.80**
 - 8013 2nd Regt. Lancer of the Guard **£7.80**
 - 8014 Trumpeter, elite coy. Line Dragoons **£7.80**
 - 8015 Musician, 15th Line Inf. 1806 **£7.80**
 - + 8016 Officer, 6th Dragoons, 1806 **£7.80**
 - + 8017 Pvt. Grenadier coy. 84th Foot 1808 **£7.80**
 - 8018 Officer Horse Artillery of the Guard **£7.80**
 - + 8019 Rifleman, 60th Rifles Peninsular Period .. **£7.80**
 - + 8020 Highland Put. 42nd Regt. 1808 **£7.80**
 - 8021 Mounted French Cuirassier, 1808 .. **£17.45**
- *Metal bases, all others wooden.

AUSTRALIA: BATTLEFIELD, CLISSOLD PARADE, CAMPSIDE, N.S.W. 2194

TO ALL OUR UNITED STATES CUSTOMERS

ALL OUR PRODUCTS ARE NOW AVAILABLE DIRECT FROM THE U.K. SEND NOW FOR OUR FULL LISTING — MANY ITEMS NEVER BEEN AVAILABLE IN THE STATES — INTERNATIONAL REPLY COUPON WILL SECURE IMMEDIATE RETURN. U.K. QUALITY DIRECT TO YOU!



FAST EFFICIENT DIRECT MAIL ORDER SERVICE - SEND 40p PLUS 15p POSTAGE FOR FULL LISTING.

SHOP AND SHOWROOM ON THE PREMISES, HUNDREDS OF PAINTED FIGURES, OPEN OFFICE HOURS PLUS SATURDAY 10 a.m. TO 12.30 p.m.

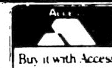

Clydecast Products

Aug 84



CCF40 Mameluke Imperial Guard (1812/14)
Price £5.50 Plus 10% P&P

CCF41 French Infantryman (Franco-Prussian War)
Price £5.50.



FOR OUR FULL LISTS CONTAINING DETAILS OF ALL THE FIGURES IN OUR 75mm, 80mm, AND 110mm RANGE, SEND 40p (REFUNDABLE ON ORDER) FOR OUR ILLUSTRATED CATALOGUE. ALL ORDERS DESPATCHED WITHIN 3 DAYS OF RECEIPT.

10 MIDLOTHIAN DRIVE, GLASGOW G41 3RA.
Tel: 041-649-3831 Hours of business: 9 a.m. to 5 p.m. Mon. to Thurs.

