

1245



Belgo Models

white metal figures
& accessories

1/48 - 1/35 - 54 mm

91 - 92



COMMENT REALISER ET PEINDRE VOS FIGURINES

Matériel nécessaire: Papier de verre très fin ou laine de fer o5 - une lime fine - cutter ou X-acto

Les couleurs: Humbrol matt: Khaki HF.1 - Matt 29 - Matt 26 - Matt 33 - Matt 24 - Matt 61 - Khaki drill HM.8 - MC.21 - sand Hl.4 - Couleurs à l'huile: Terre de sienne brûlée - Ocre jaune - Chair - Rouge - Blanc - Noir.

Les pinceaux et brosses: En martre. Plat: dit langue de chat n° 2 - 4 - 6. Rond: Rein Kolinsky ou Winsor & Newton n° 1 - 0 - 00 - 000.

Préparation de la figurine: Bien nettoyer la figurine à l'eau savonneuse pour enlever le talc de protection, sécher avec un chiffon. Enlever les bavures avec le cutter ou la fine lime. Passer la figurine à la paille de fer o5 pour lui donner un polish unit. Enlever la poussière de limaille avec un pinceau doux (genre aquarelle n° 12).

Couleur de fond:

Visage et mains: Humbrol matt 61 flesh pour ton clair - Humbrol matt Hl.4 sand pour ton foncé.

Uniformes: Américain et allemand - Humbrol Khaki HF.1 - Laisser sécher 24 heures.

Technique peinture visage et mains: Couvrir toutes les parties avec la couleur à l'huile terre de sienne foncée. Avec un autre pinceau souple et sec, enlever l'excédent de couleur et essuyer le pinceau sur un chiffon propre, répéter l'opération jusqu'à obtenir un ton uniforme, la couleur de fond doit être apparente. Avec un pinceau plat n° 2, éclaircir le front, arête du nez et narines, menton, mâchoire inférieure et gorge, avec 3/4 d'ocre + 1/4 chair, bien essuyer le pinceau dans un chiffon avant l'opération — travaillez léger — répéter l'opération si le contraste n'est pas marquant.

Pommettes: 1 pointe de rouge, bien fondre la couleur — un mélange d'ocre et rouge donnera un ton moins rosé.

Après avoir fait les yeux, et pour un regard plus profond, foncer entre la paupière supérieure et le sourcil en partant du nez vers l'extérieur avec la terre de sienne.

Pour une barbe de quelques jours: (après 2 à 3 jours de séchage) mélanger du bleu foncé et de la terre de sienne — bien essuyer le pinceau et tamponner la partie du visage.

Uniforme: En dry-brushing avec la couleur Humbrol. Ne pas mélanger vos couleurs, prendre le fond avec un tourne-vis et ajouter quelques gouttes du liquide. Mélanger par moitié, MC.21 et matt 29, bien essuyer le pinceau et couvrir l'uniforme en dry-brushing. Pour éclaircir les reliefs et plis, ajouter un peu de jaune matt 24 dans le même mélange. Travaillez toujours très léger, les différences de tons apparaissent lorsque la couleur sèche.

Peindre les webbs et ceinturons en Khaki drill HM.8. Avant de terminer, soutenir tous les détails (contour poches, équipement etc...) avec un jus de noir matt très dilué. Terminer avec un mélange de Khaki drill + blanc, en dry-brushing très léger sur toutes les parties les plus apparentes.

Uniforme allemand: Même technique mais avec les couleurs et dans l'ordre suivant: 1. Field grey HM.6 - 2. Field grey HM.6 + blanc. L'équipement et les bottes sont en cuir noir satiné.

Armements: Parties bois: terre de sienne sur fond sand Hl.4. Parties métalliques: en dry-brushing avec un mélange de couleur à l'huile noir plus un peu de poudre d'argent.

Un dernier conseil pour cette fois: Ne cherchez pas à obtenir le ton en une seule couche, procédez par étape, vous obtiendrez un meilleur résultat. Quand vous changez de ton de couleur, ne pas vous servir du pinceau que vous venez de nettoyer, employez un sec et propre.

Bonne peinture à tous.

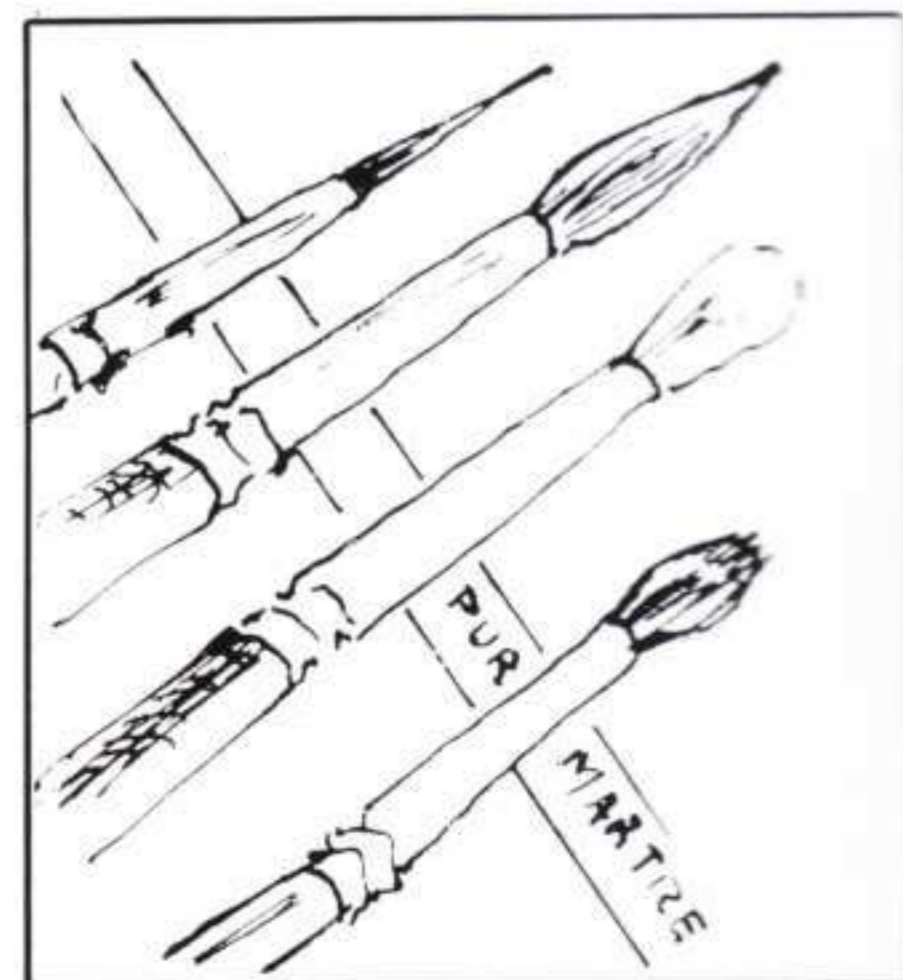
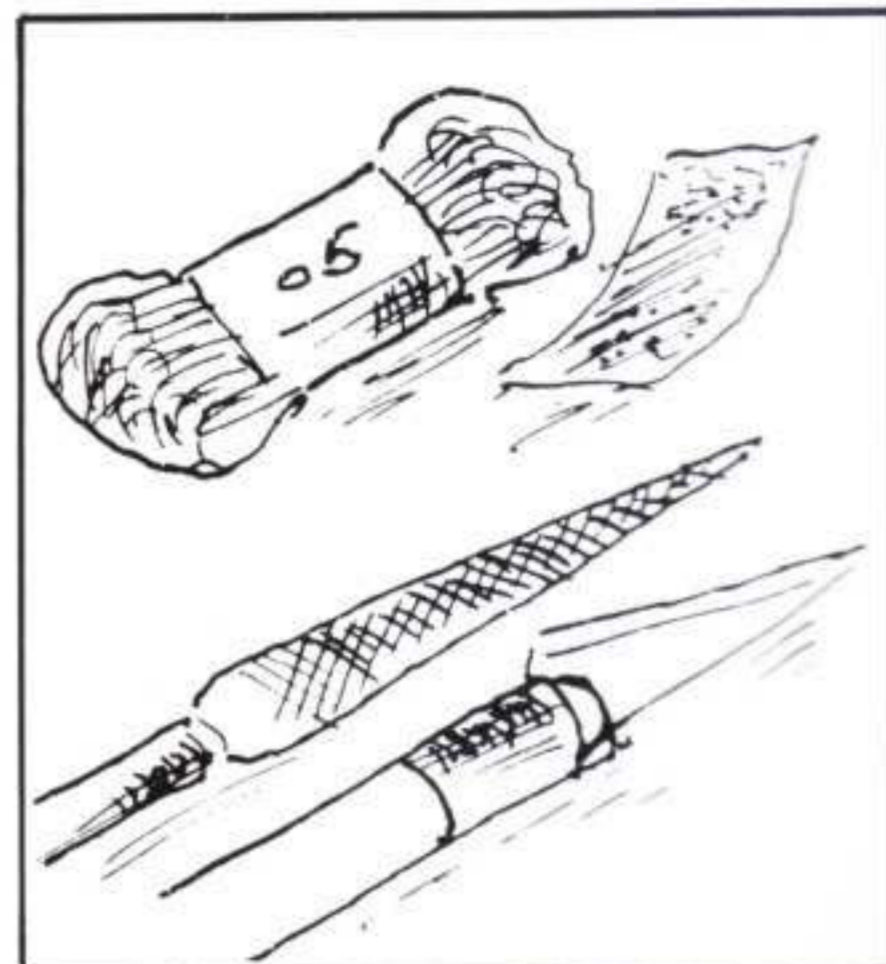



N° 118

PEINTURE ET REALISATION DES DIORAMAS
 PAINTING FIGURES AND DIORAMAS REALIZATION
J.M. CHARNEUX



N° 128



N° 129



N° 111



German radio crew walking
 along a field with enclosing barbed wire.
 Equipe de radio allemande marchant
 le long d'un champ cloturé de fil barbelé.
 Figures - Figurines: BG. 121 - 122



ALLIED FORCES GENERALS

W.W.II NORTH-WEST EUROPE

1/35 SCALE



Sp/Ar/7
Para 101st airborne



Sp/Ar/8
Para 101st airborne
Hairstyle Iroquoi



Sp/Ar/10
G.I. on overcoat



Sp/Ar/11
G.I. standing at rest



Sp/Ar/12
M.P.



Sp/Ar/13
G.I. with dixy



Sp/Ar/14
Para walking



N° 165
U.S. scout
EUROPE 40-45



N° 165/2
U.S. scout
EUROPE 40-45



N° 166
G.I. ARDENNES 44



Avance



Contre-



Front allemand du 22 au 24 déc. 1944



Attaques alliées après le 25 déc. 1944

« on de Bastogne »

0 30 km

U.S. ARMY INFANTRY

W.W.II NORTH-WEST EUROPE

1/35 SCALE

Objectif 6^e Armée

ERS

EL

ne

U.S.

Ourthe

Hotto

Marche

Grandmenil

Vielsam

St-Vith

6^e Pz

5^e Pz

urg

St. Vith

Houffalize

Roche

Givet

Celles

Dinant

Charleroi

Sambre

6^e Pz

Butgenbach

Imédy

astogne

Moselle

0 30 km

Avance

Contre

Front a

Attaques alliées après le 25 déc. 1944

du 22 au 24 déc.

écembre 1944

N° 151
U.S. tank crew in one piece twill suit

N° 152
U.S. tank crew in front field jacket

N° 153
U.S. tank crew in field jacket M.41

N° 167
Sherman tank crewman

N° 168
Sherman tank crewman

N° 170
U.S. tanker with field glasses

N° 171
U.S. off. reading a map

N° 172
US tanker-driver US tanker (with stretch) turret

N° 169

U.S. ARMY TANK CREW

W.W.II NORTH-WEST EUROPE

1/35 SCALE



N° 160
Baseball player in
army 1944
"PITCHER"



N° 161
Baseball player in
army 1944
"BATTER"



N° 174
Ambulance man
1944, seated



N° 175
Ambulance man
1944, standing



N° 177
U.S. Black staff
seated



Sp/Ar/9
Black staff



N° 201
British para-Arnhem
1944. Sgt.
Glider pilot regt.



N° 202
British para-Arnhem
1944. Sgt.
Bren gunner-
1st Airb. div.



R. 010



Attaque le 20 déc. 1944
Saillant —
Avance —
Contre-attaques alliées du 22 au 24 déc.
Front allemand le 25 décembre 1944
Attaques alliées après le 25 déc. 1944

ALLIED FORCES U.S.ARMY-BRITISH ARMY

W.W.II NORTH-WEST EUROPE

1/35 SCALE

SOON
203

N° 204

N° 205

N° 173

N° 206

N° 176

St-Vith le 20 déc. 1944
allemande — —
Contre-attaques alliées du 22 au 24 déc.
Front allemand le 25 décembre 1944
Attaques alliées après le 25 déc. 1944

« Hérisson de Bastogne »
0 30 km

ALLIED FORCES U.S.ARMY-BRITISH ARMY

W.W.II NORTH-WEST EUROPE

1/35 SCALE



Sp/Ar/51
VON RUNDSTEDT



Sp/Ar/52
VON MANTEUFFEL

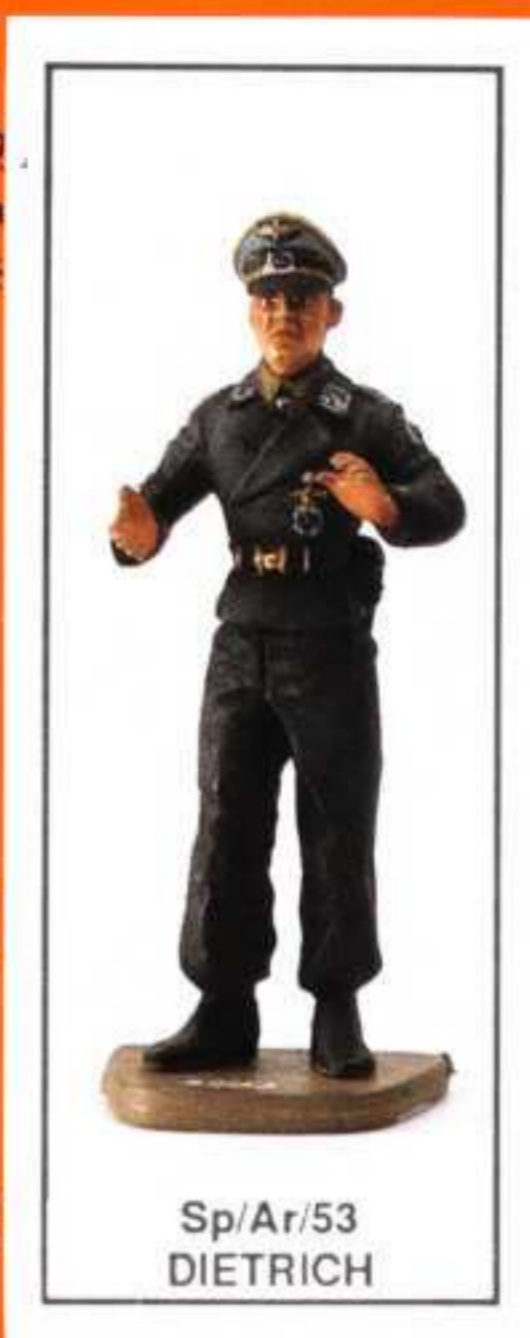

Sp/Ar/53
DIETRICH



Sp/Ar/54
MODEL



Sp/Ar/55
VON DER HEYNDE



Sp/Ar/56
PEIPER



Sp/Ar/57
SKORZENY



N° 123
Obersturmführer
WITTMANN 'LAH'
Regimental
Commander and
hero of Normandy
front.



N° 125
German off. in
parade dress.
Generalleutnant -
1939.



N° 126
Organization Todt -
1944.
OT-
Einsatzgruppenleiter I
Service uniform



Avance



Contre-attaque



Front allemand



Attaques alliées après le 25 déc. 1944

du 22 au 24 déc.
décembre 1944

« Son de Bastogne »

0 30 km

GERMANY Oberkommando des Heeres



N° 101
SS. Pz. Div.
'Hitlerjugend'
France 1944



N° 103
SS. Pz. Div. 'Wiking'
1943



N° 104
SS. Pz. Div. 'Wiking'
Poland 1944
Mechanic



N° 105
Tank officer



N° 116
German tank officer
1944



N° 117
German tank officer
Div.
Großdeutschland



N° 118
Oberscharführer
tank commander
Div. PRINZ-EUGEN



N° 120
German tanker



N° 124
Oberscharführer
WOLL
Gunner of Wittmann



Saillant
Avance
Contre-
Front allemand le 25 décembre 1944
Attaques alliées après le 25 déc. 1944



GERMANY Panzerbesatzung (TANK CREW)

W.W.II NORTH-WEST EUROPE

1/35 SCALE



Sp/Ar/58
German para with
U.S. carton of cig



Sp/Ar/59
German para without
helmet



Sp/Ar/60
German inf. with
mine



Sp/Ar/61
German inf. with
cartouches



Sp/Ar/62
German para with
helmet



N° 114
Panzergrenadier,
1944



N° 115
Panzergrenadiers,
1945
Oberfeldwebel



N° 121
Radio team.
Man carrying radio



N° 122
Radio team.
Man carrying battery



N° 127
German Elite
Honour Guard



Avance
Contre-
Front allemand
Attaques alliées après le 25 déc. 1944



GERMANY Infanterie (INFANTRY)

W.W.II NORTH-WEST EUROPE

1/35 SCALE



N° 301



N° 302



N° 303



N° 304



N° 305



N° 306



N° 307



N° 308

GERMAN CREW FOR 12,8 FLAK 40

W.W. II EAST EUROPE

1/35 SCALE



N° 119
German leaned
Europe



N° 110
SS.Pz. Div.
'Totenkopf' Russia
1942



N° 113
SS. Pz. Div. in
Russia



N° 102
SS Unterscharführer
Panzergrenadier
Div. 'Das Reich' regt.
'Der Führer' 1943



N° 106



N° 107

W.W. II EAST EUROPE -RUSSIAN

1/35 SCALE

N° 401



N° 402



N° 403



N° 404



N° 405



N° 406

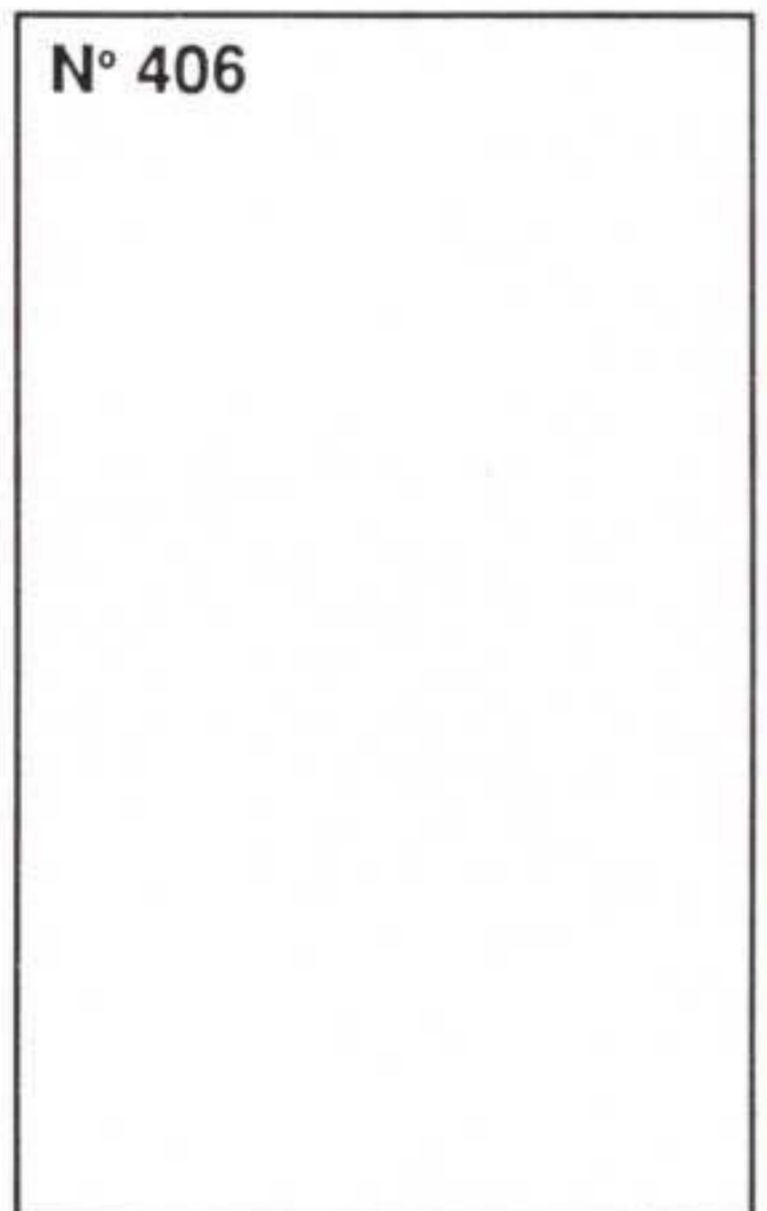

N° 407



N° 408



N° 409

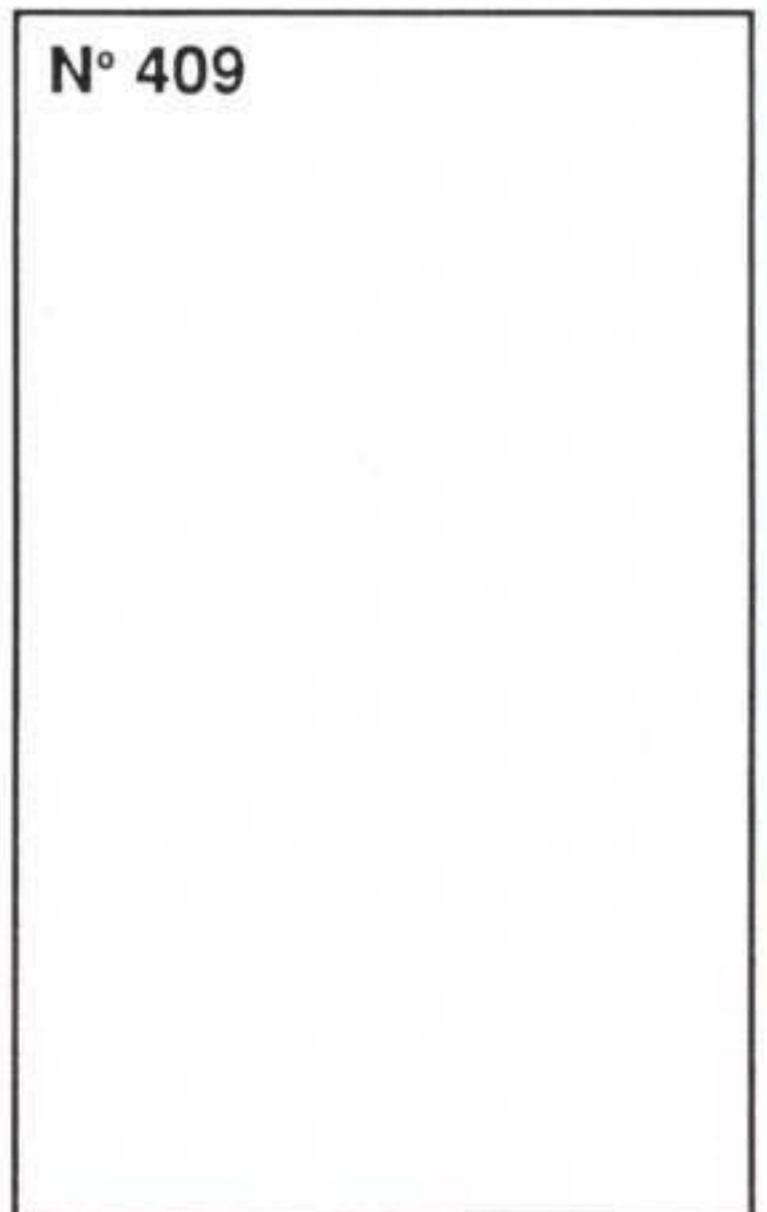

VIETNAM WAR 1/35 SCALE



THAILAND

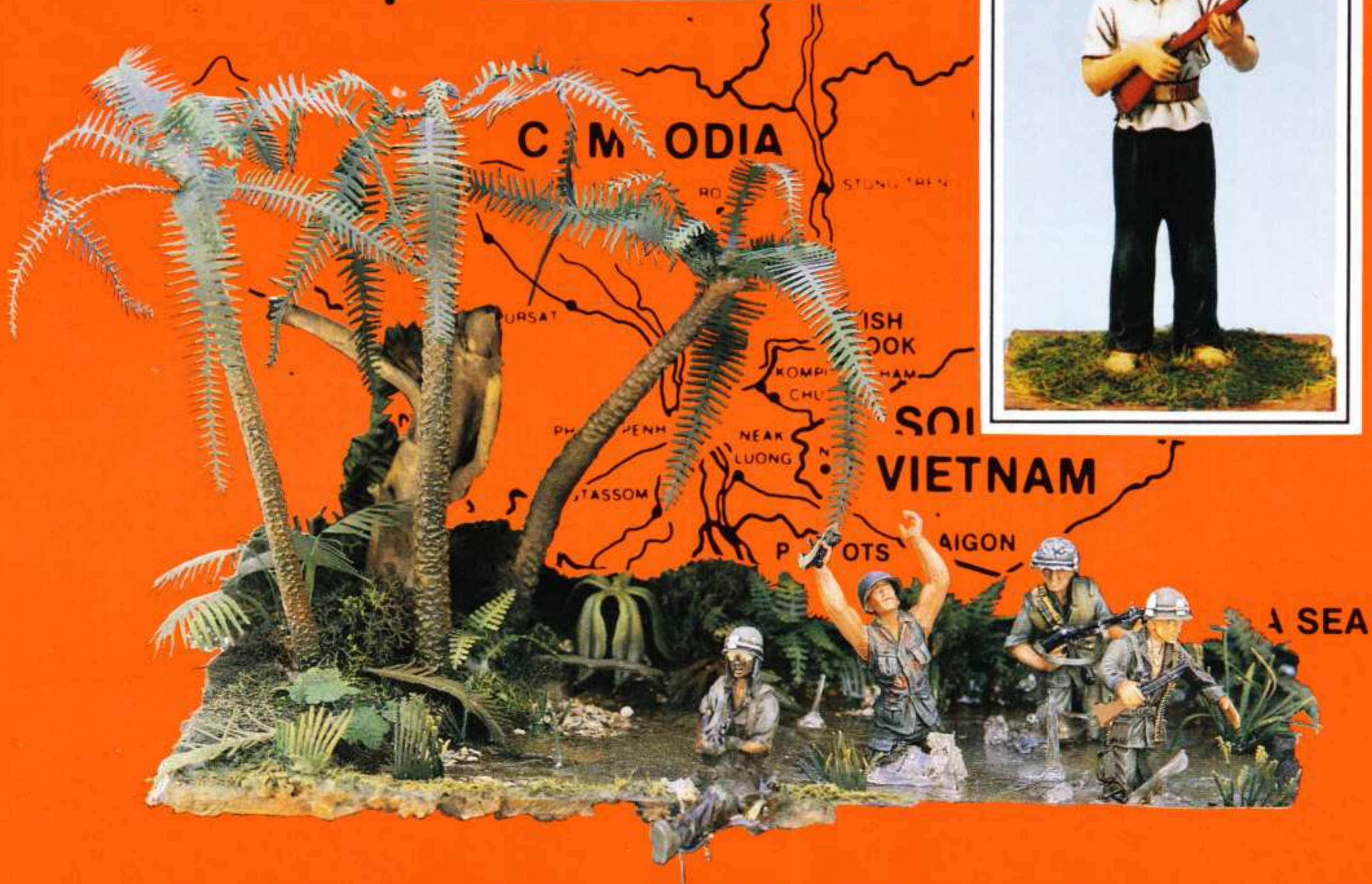

VIETNAM WAR

1/35 SCALE



VIETNAM WAR

1/35 SCALE

N° 180



N° 181



N° 182



N° 183



N° 184



N° 185



N° 186



N° 187



N° 188



VIETNAM WAR

1/35 SCALE

N° 178



N° 179



N° 189



N° 190



N° 191



N° 192



N° 194



N° 198

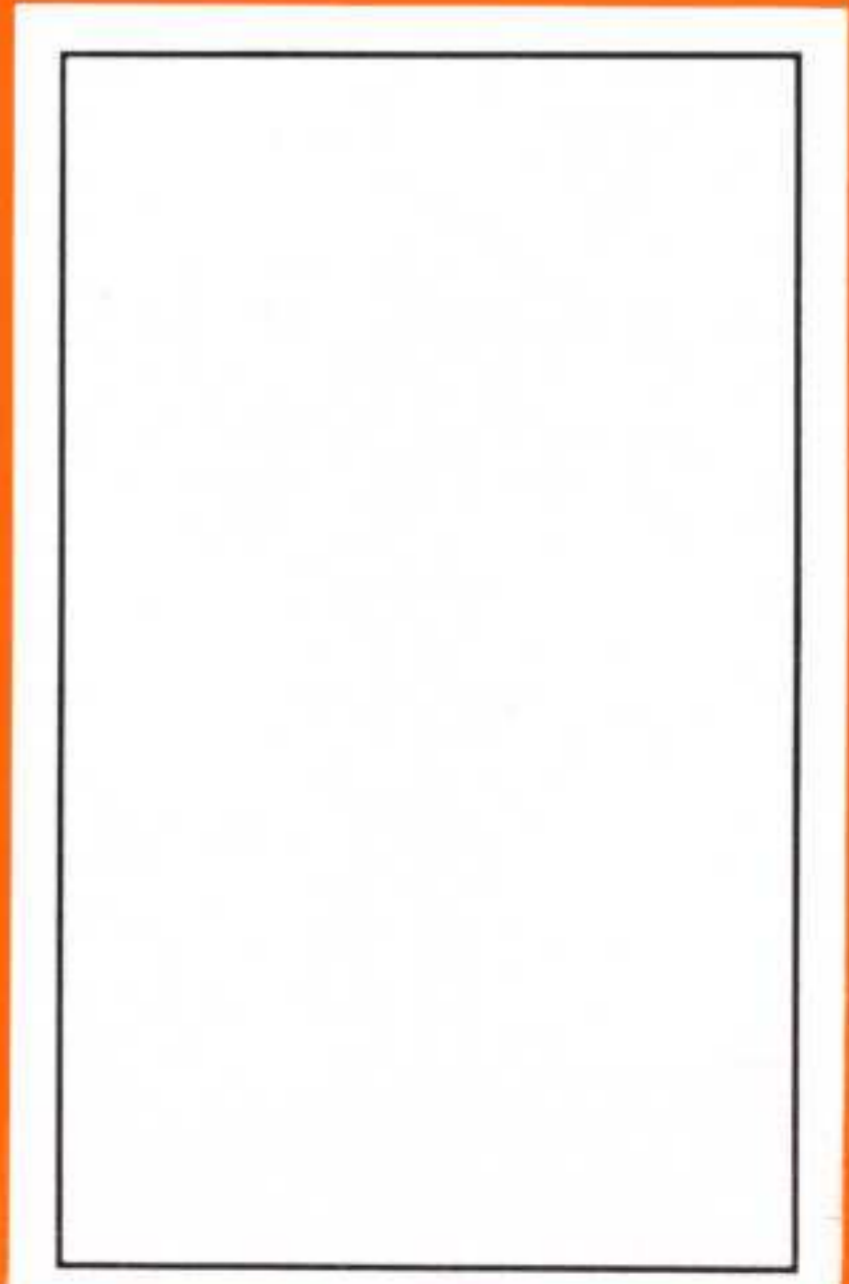

VIETNAM WAR

1/35 SCALE

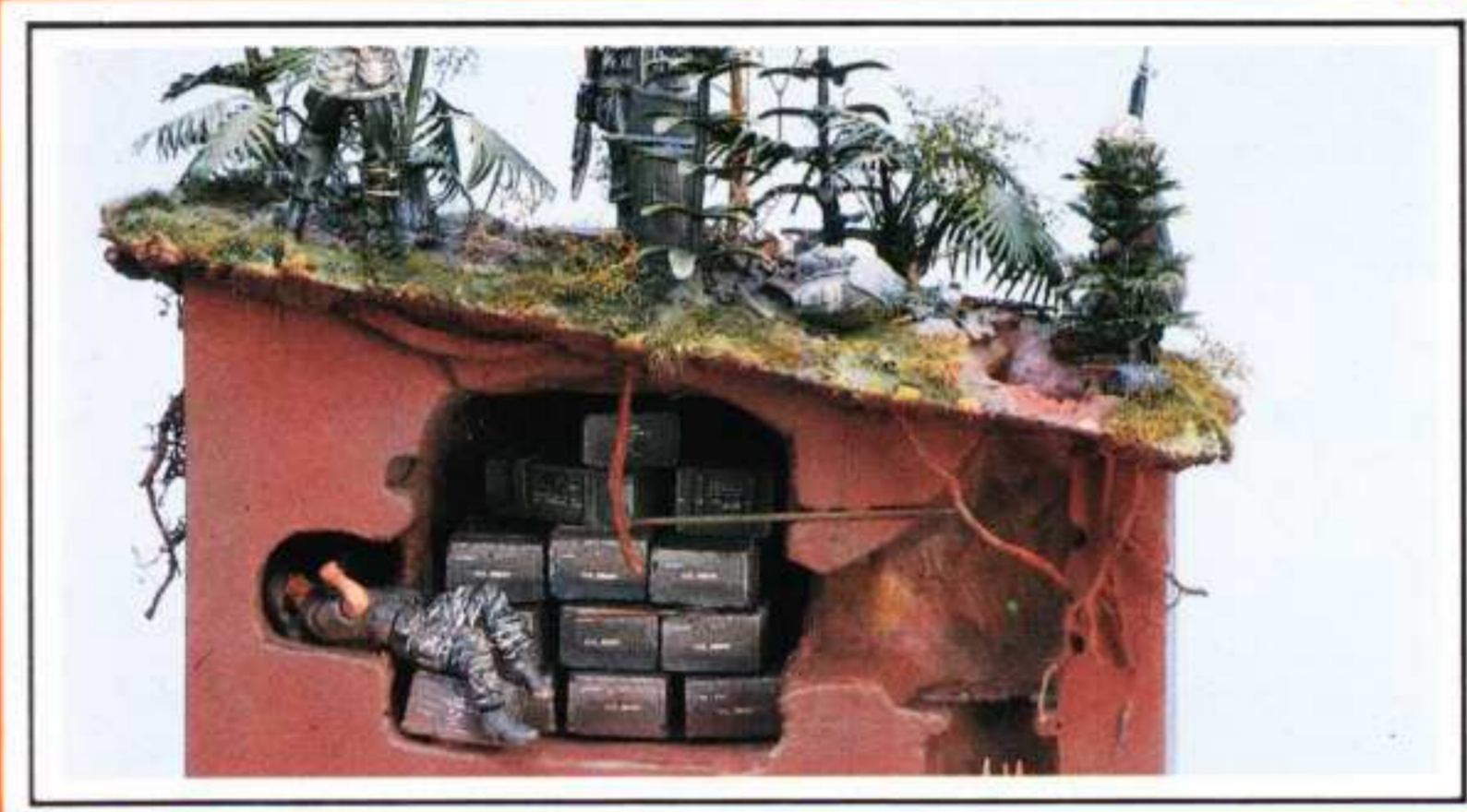

R.007

FIG. AND ACC. NOT INCLUDED

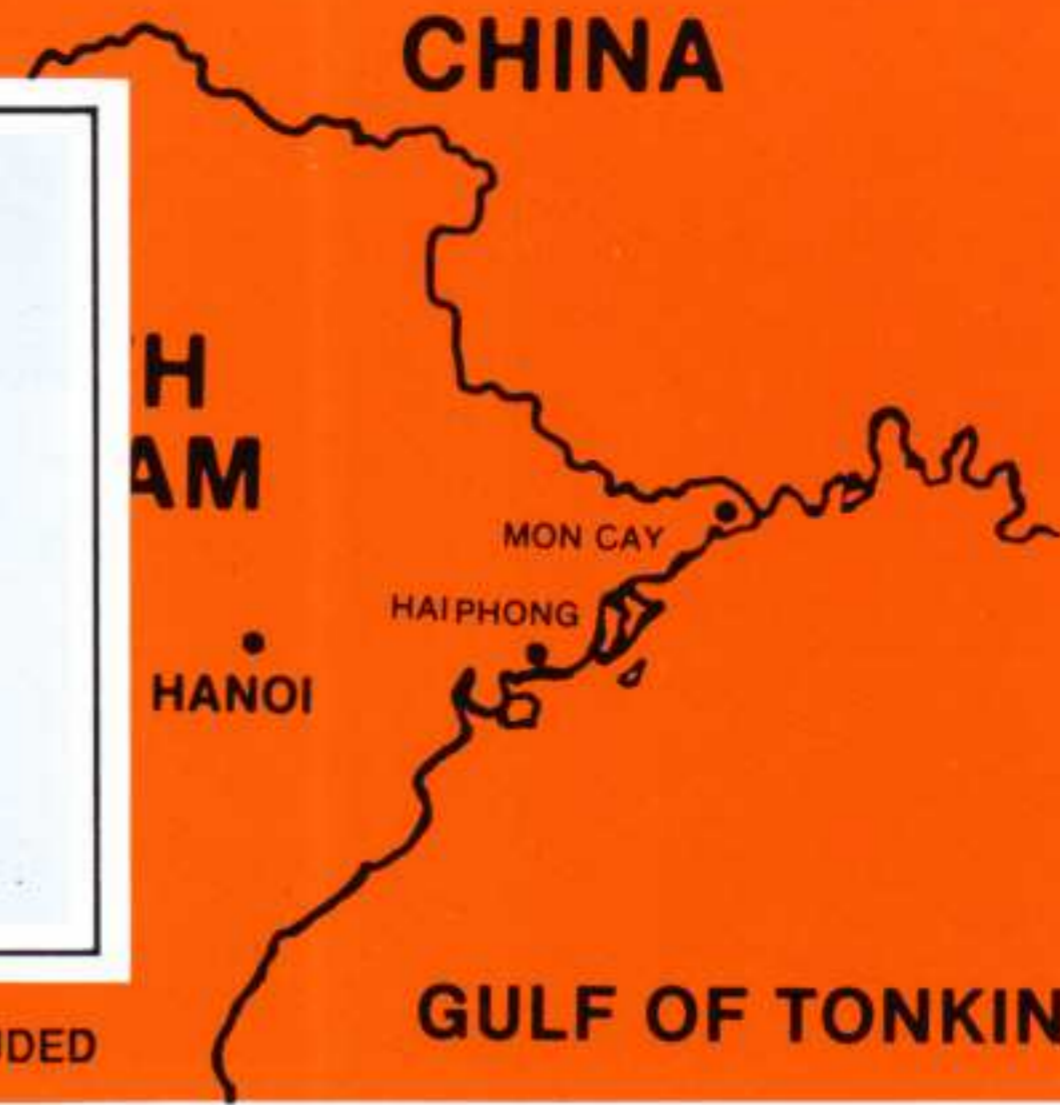

R.008

FIG. AND ACC. NOT INCLUDED



GULF

CHINA SEA

R. 011 V.C. HUTTE
V.C. HUT

RESIN ACCESSORIES



R. 017

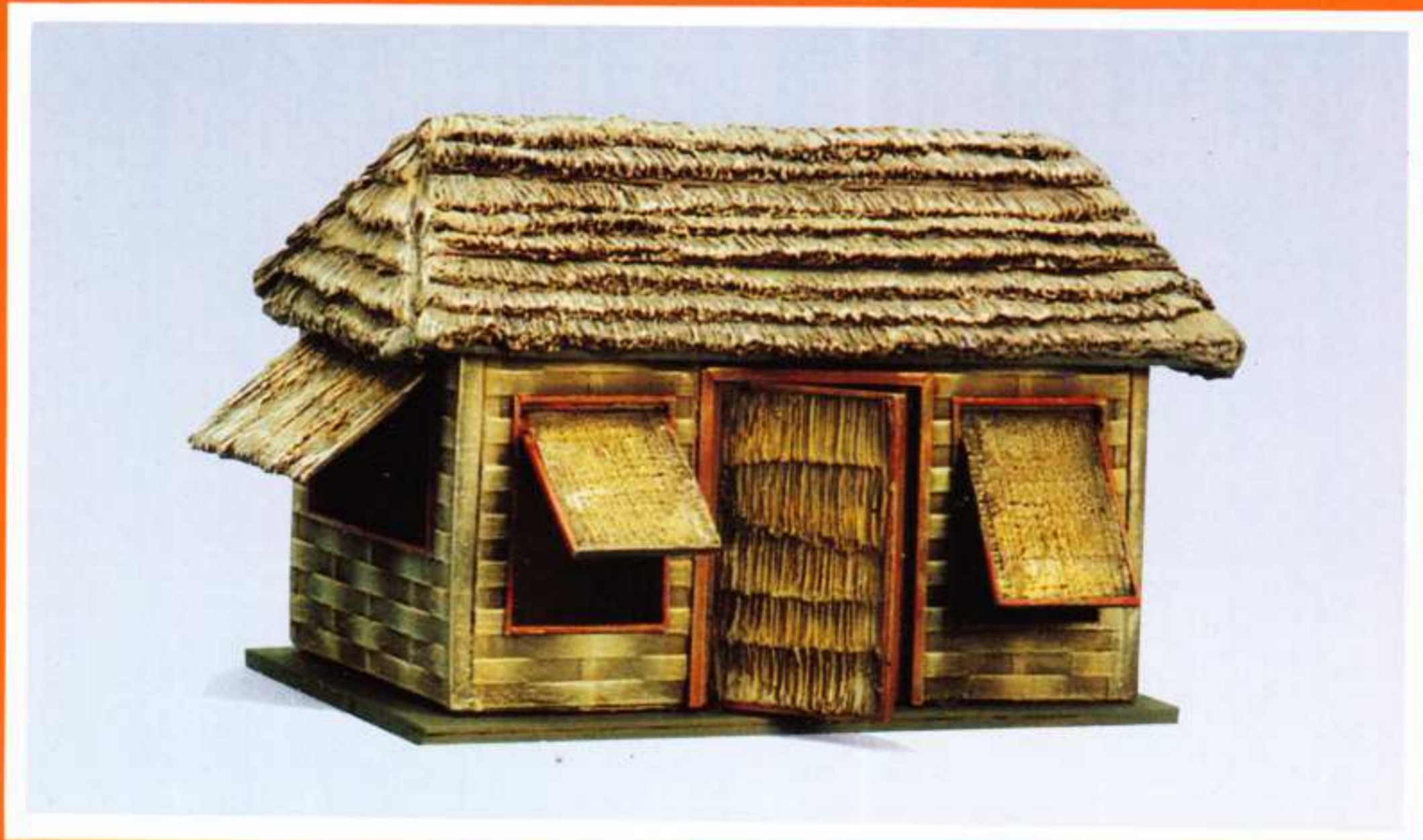

R. 016



R. 014

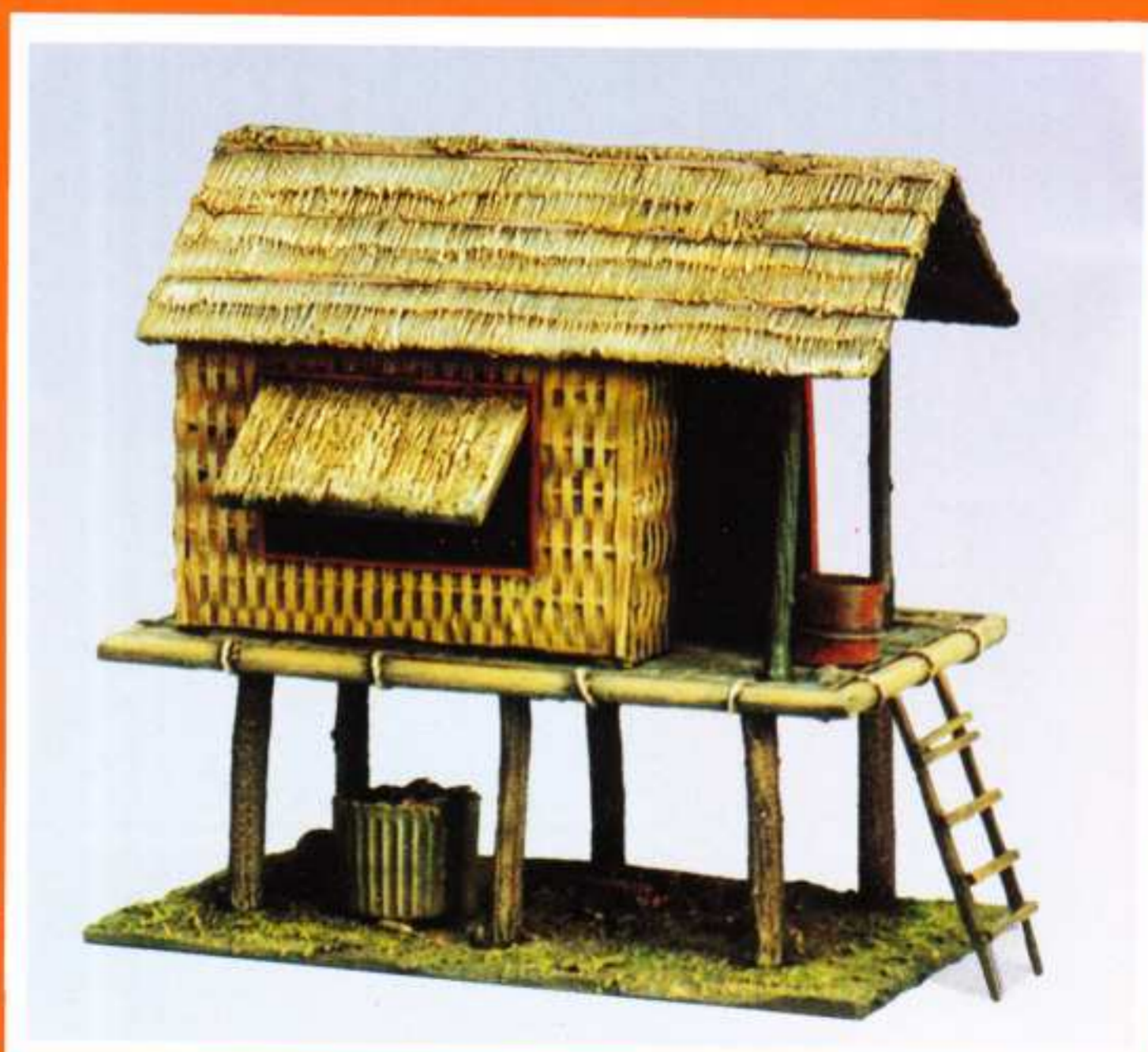

R. 015

RESIN ACCESSORIES

GULF WAR-DESERT STORM U.S.ARMY

1/35 SCALE

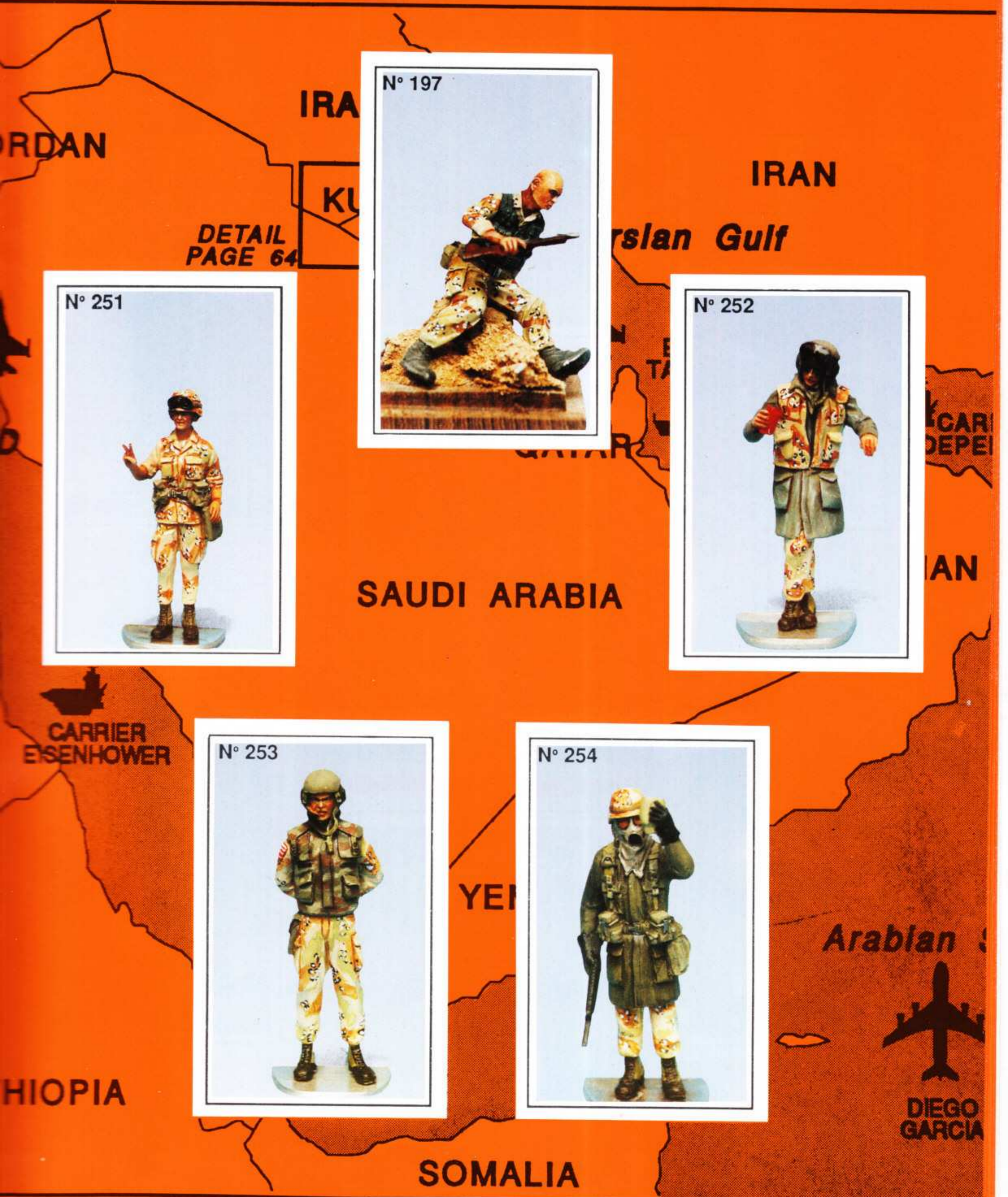

DETAIL PAGE 64

N° 197



N° 251



N° 252



SAUDI ARABIA

N° 253



N° 254



SOMALIA

DIEGO GARCIA

CIVILIANS

1/35 SCALE

N° 509



N° 512



N° 511



N° 510



N° 514



N° 515



N° 513



CIVILIANS

1/35 SCALE



N° 501
Civilian series - Man



N° 502
Civilian series - Woman



N° 503
Parochial priest



N° 504
Religious cornet



N° 505
Civilian in waistcoat



N° 506
Civilian worker



N° 507
Civilian woman



N° 508
Civilian old man

N° 516



N° 517



RESIN ACCESSORIES

1/35 SCALE

R. 001



R. 002



R. 003



R. 004



R. 005



R. 006



R. 009



ETCHED BRASS

1/35 SCALE

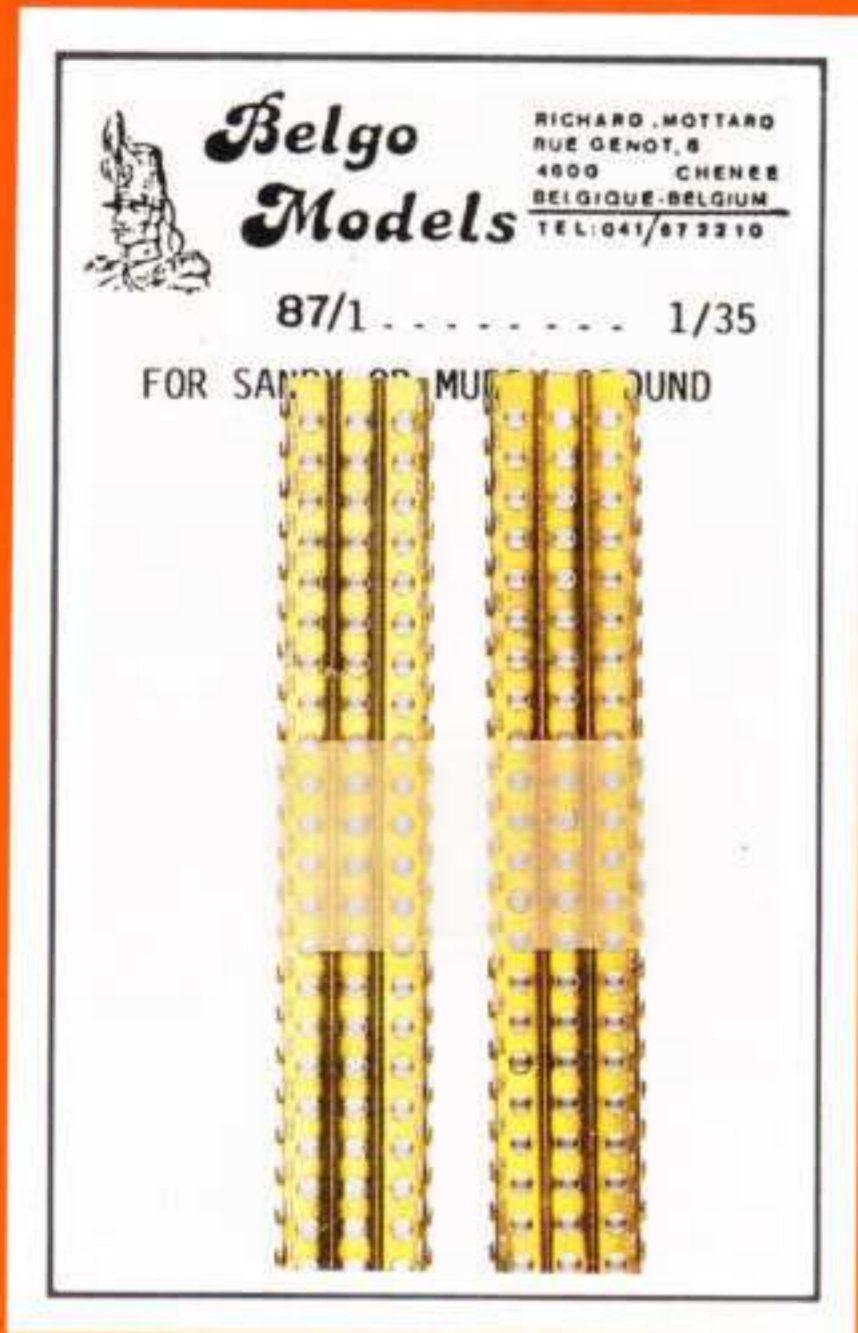

87/1



87/2

087/2 - P.S.P - Tôles perforées
 087/2 - Mechanical wrench - Clef



87/3



87/4

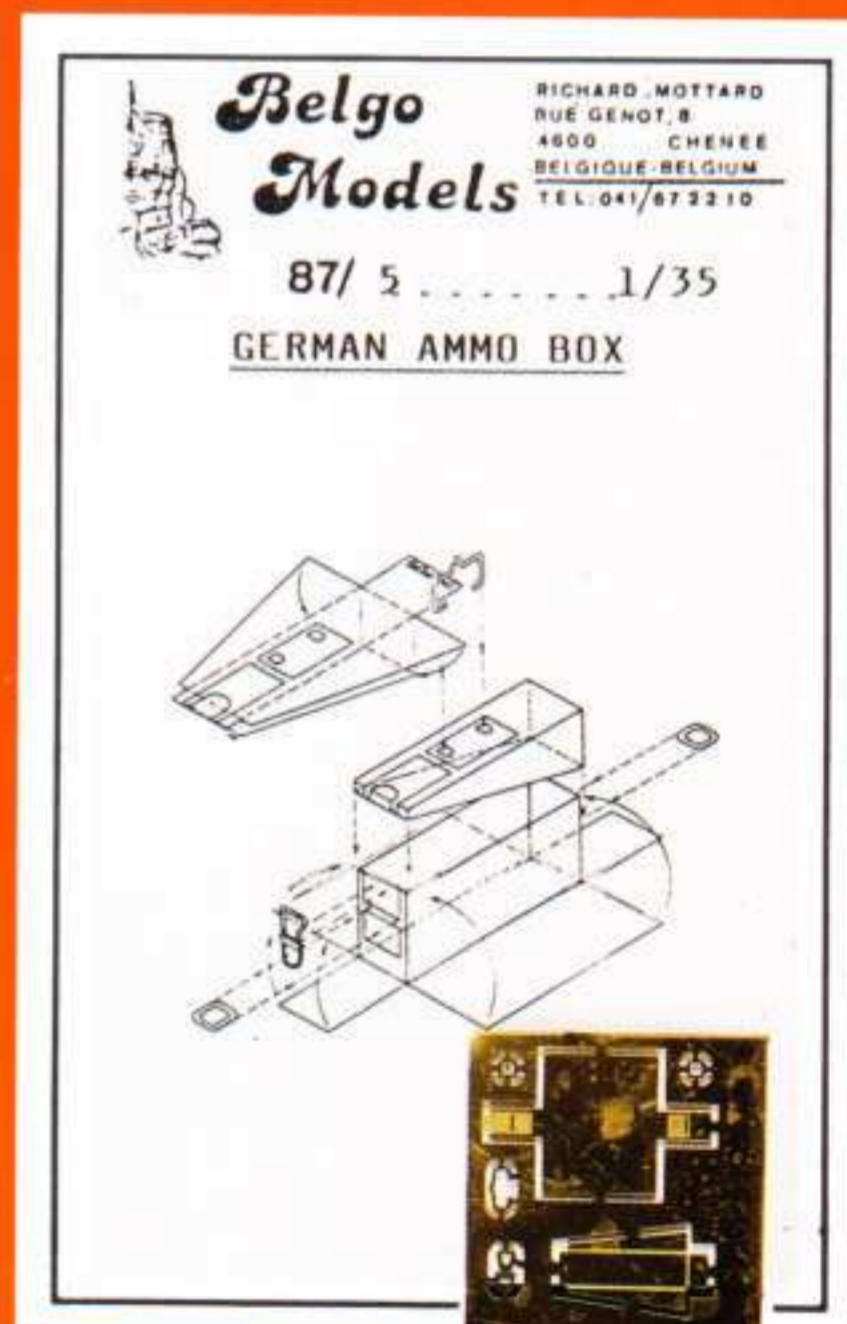

87/5

087/3 - Personal accessories set - Set d'accessoires individuel
 087/4 - German and U.S. rifles slings - Bretelles de fusil US. et Allemande
 087/5 - German ammunition boxes - Boites a munitions Allemande

U.S. AIR FORCE / NAVY

1/48 SCALE



Kit P. 001 Pilot and engeneers - Pilote et mecanos WWII



Kit P. 002 1 aircraft and 1helicopter pilots, 3 deck crew.
1 pilote d'aviation et 1d'helicpter, 3 personnel de pont



Kit P.003 Deck crew - Personnel de pont.

SOON
P. 004 CATAPULT
CREW

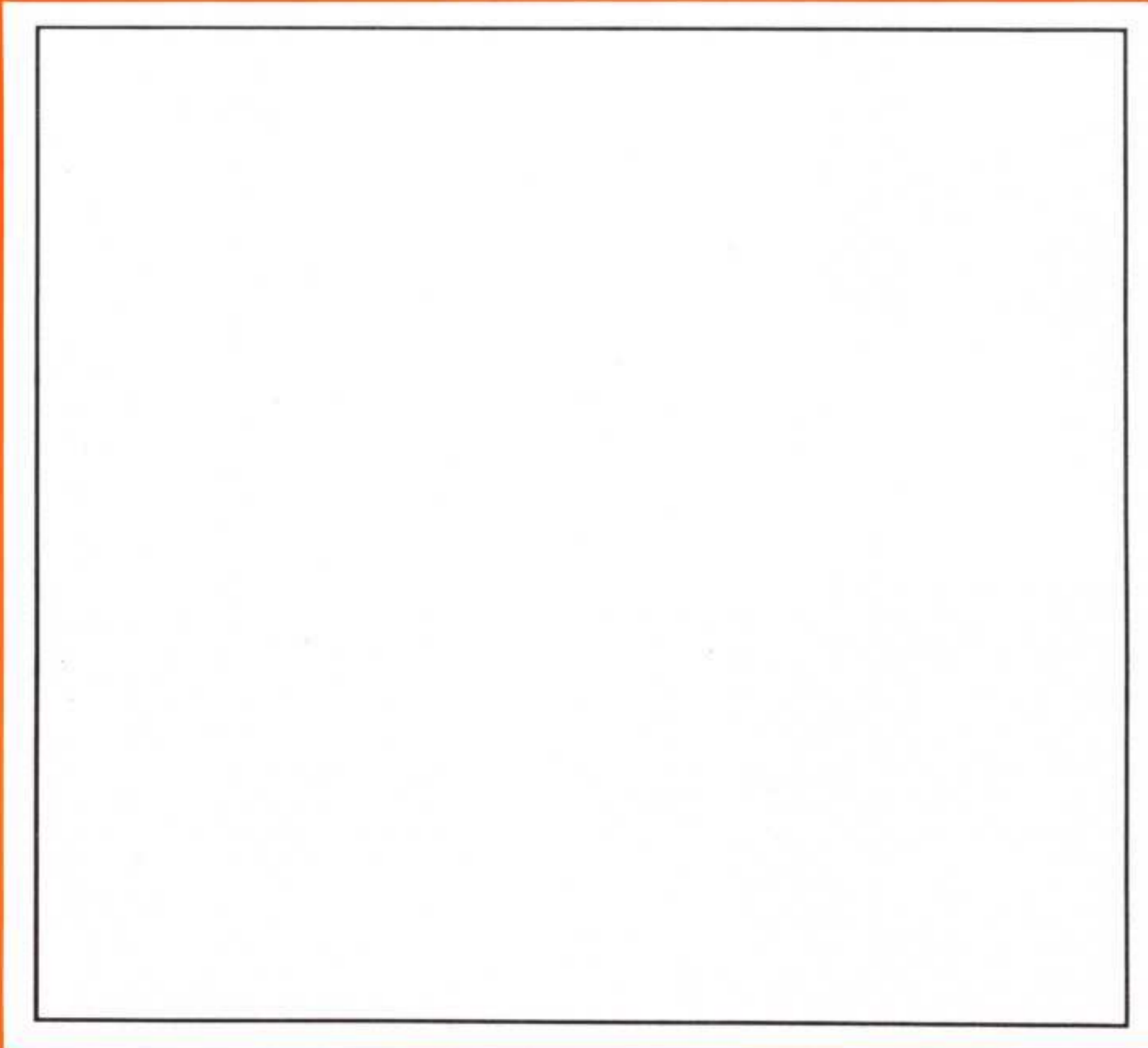

Two men from the 173rd airborne brigade are waiting for a helicopter to carry the body of a comrade.

Deux soldats de la 173^{ème} brigade aéroportée attendant un hélicoptère pour emporter le corps de leur camarade.

Figures - Figurines: BG 182 - 183 - 184



Soldier walking upon tree trunks to cross a river bed. The vegetation is made with real plants.

Soldat traversant une rivière sur 2 troncs d'arbre. Décors en végétation naturelle.

Figure: BG 185 and acc. R. 008 - Transparent resin for water - Resine transparente pour l'eau.

VIETNAM WAR

Somewhere in the jungle, an U.S. patrol, tired of cutting its way through a dense vegetation, is wading its way in the river...

A bough has broken under the weight of a man and his equipment. The trooper is falling into the water while his M60 lands upon the head of another fellow; the latter drops his arm and tries to protect himself against the falling gun with his two arms.

CONVERSION:

One or two arms of Tamiya's 1/35th serie will give the movement of the fall to the man who's still clutching the bough.

Parts: Trees of the jungle are made with rosebushes roots. Foliage are Scale Link model.

Transparent resin for water.

Figures: BG 181- 185

VIETNAM WAR

Quelque part au Vietnam, une patrouille US. fatiguée de se frayer un chemin à travers une végétation dense, patauge dans le lit d'une rivière. Une branch s'est cassée sous le poids d'un homme. Le soldat, son M60 chute sur la tête de son copain, ce dernier perd son arme et essaye de se protéger avec le bras.

CONVERSION:

Un ou deux bras de la série Tamiya 1/35^{ème} donneront le mouvement de l'homme qui tombe et qui se retient à une branche.

Pièces utilisées: Racines de rosiers pour les arbres de la jungle. Les feuillages sont de Scale Link. De la résine transparente pour l'eau. Figurines: BG 181 - 185



DIORAMA VIETNAM WAR
 Wounded "Platoon" soldier. Setting realized
 with wild plants.
 Soldat de "Platoon" blessé. Décors réalisé
 avec des plantes sauvages.
 Figure - Figurine: BG 180

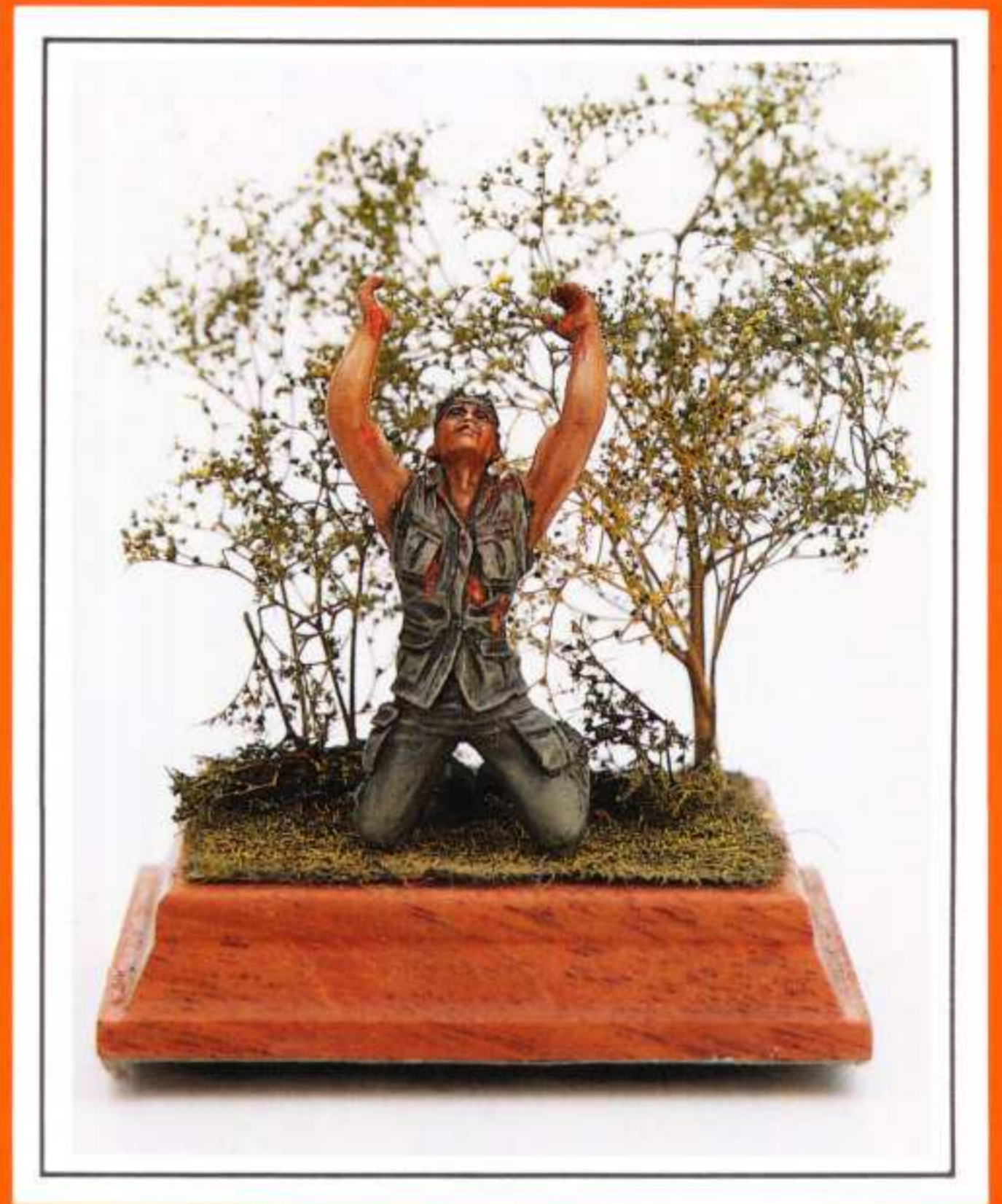

Soldier running on a dam of paddy field.
 Soldat courant sur une digue de rizière.
 Figure - Figurine BG 181

Walls are made with plaster.
 Corugated irons from BG accessories (not available
 yet).
 The flag is cut in a alu sheet.
 Le mur est fait avec du plâtre.
 les tôles ondulées font partie des accessoires BG
 (pas encore disponible).
 Le drapeau est découpé dans une feuille d'alu.
 Figure - Figurine: BG 188



ARNHEM 1944: The German "Unteroffizier" is in a rather awkward posture when an English group, walking across the backgardens, falls upon him. The paratroopers are part of the troops dropped around "Arnhem" which were encircled by the German "Elite troop". In such a position the English tried to avoid steet skirmishes and prefer to prowle across fields and gardens. The bautering officer takes the arm of the German while his men are surveying for a possible intervening German soldier's friends.

Parts: R.010 Back garden W.C. Figures: 201 - 206. The German seated is included into the kit R. 010

Conversion: The walking English para no. 201 is now in awaiting position. The position of the head of the figure no. 206 has been slightly modified.

ARNHEM 1944: Le sous officier Allemand est dans une position bizarre quand un groupe Anglais traversant les jardins lui tombe dessus. Les paras Anglais font parties des groupes laché autour d'Arnhem et qui sont encerclé par des troupes d'elite allemande. Dans une telle situation les anglais evitent les combats de rue et préderent progresser a travers champs et jardins. L'officier goguenard prend l'arme de l'allemand pendant que ses hommes surveillant les environs contre une possible intervention allemande.

Pièces utilisées: Kit R.010, soldat assis inclu: figurines BG 201 - 206

Le para no 201 est maintenant a l'arret. la position de la tête de la figurine no 206 a été légèrement modifiée.



**BOTH BRITISH PARAS NOT INCLUDED IN KIT R. 010
LES 2 PARAS NE SONT PAS INCLUS DANS LE KIT R.010**



BIG DIORAMA: Vietnam war

Built in an empty video case. For tree trunks, foliage and water see diorama 5
 Figures - Figurines: BG 180 - 181 - 185 - 188

GRAND DIORAMA: Vietnam

Diorama fait dans une jaquette de video K7.
 Pour le troncs, feuillages et l'eau, voir diorama 5



"Ciao" "Salut"

Figures - Figurines: BG 509 - 510 et acc. R.006



Alexander the Great®
DIORAMA ACCESSORIES

Thessaloniki Greece

Distribué par
Belgo Models®

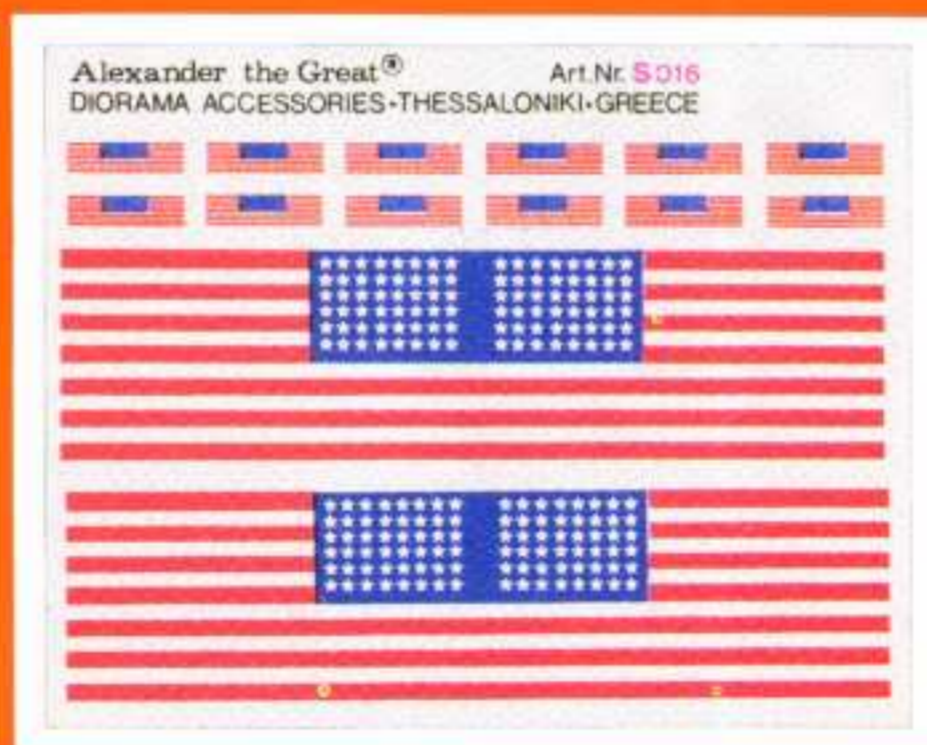

N° 21



N° 50



21 - Gendarme escorte Royale - Belge

50 - Regiment de lanciers Belge - 1851

N° 54



N° 51



51 - Regiment de guides - trompette - Belge

54 - Grenadier Belge - 1880

N° 58



N° 56



56 - Marin Belge - 1830

58 - Marin Belge - 1832

FIGURES - FIGURINES 54 mm



N° 57

N° 59

57 - Marin Belge contemporain - Belge

59 - Navy officer in oilcloth
Officier de marine en ciré.



52 - Regiment de Horion Liégeois - France 1760

55 - Mousquetaire de la maison du Roy - France

N° 55

N° 52



N° 61

N° 60

60 - Carolus Magnus
Charlemagne

61 - Eginhard chronicler monk
Eginhard moine chroniqueur

BATTLE OF THE BULGE - ARDENNES 1944

ALLIED TROOPS

Sp/Ar	1	PATTON in flying jacket
Sp/Ar	2	BRADLEY
Sp/Ar	3	EISENHOWER
Sp/Ar	4	Mac AULIFFE
Sp/Ar	5	HODGE in M43 jacket
Sp/Ar	6	MONTGOMERY in camouflage smock
Sp/Ar	7	Paratrooper 101st Division
Sp/Ar	8	Paratrooper 101st Division, iroquois hair style
Sp/Ar	9	Negro soldier in overcoat
Sp/Ar	10	G.I. in opened overcoat
Sp/Ar	11	G.I. standing at rest
Sp/Ar	12	M.P. in M43 jacket
Sp/Ar	13	G.I. with dixy
Sp/Ar	14	Paratrooper walking

GERMAN TROOPS

Sp/Ar	51	Von RUNDSTEDT in overcoat
Sp/Ar	52	Von MANTEUFFEL
Sp/Ar	53	DIETRICH in black tank uniform
Sp/Ar	54	MODEL in black leather overcoat
Sp/Ar	55	Von Der HEYNDE, paratrooper commander
Sp/Ar	56	PEIPER pointing with left arm
Sp/Ar	57	SKORZENY
Sp/Ar	58	Paratrooper with U.S. carton of cigarettes
Sp/Ar	59	Paratrooper without helmet
Sp/Ar	60	Infantry soldier with mine
Sp/Ar	61	Infantry soldier with ammo belt
Sp/Ar	62	Paratrooper with helmet

GERMAN ARMY

101	SS Pz.Div. Hitlerjugend 1944 - Panzergrenadier	115	Panzergrenadier 1944-1945, Oberfeldwebel	127	German elite honour guard
102	SS Pz.Div. Das Reich 1943 - Unterscharführer	116	German tank crew, officer	128	German SS Obersturmführer - Service dress 1939
103	SS Pz.Div. Wiking 1943 - Tanker	117	German tank officer, Div. Großdeutschland	129	German SS Gruppenführer - Police formation 1942
104	SS Pz.Div. Wiking 1943 - Mechanic	118	SS Oberscharführer tank commander 1943	301	German crew 12,8 Flak 40 - gunner
105	SS Pz.Div. Wiking 1943 - Tank officer	119	Private in overcoat and field cap	302	German crew 12,8 Flak 40 - with binocular
106	Panzergrenadier 1943	120	German tanker in two pieces reversible winter suit	303	German crew 12,8 Flak 40 - radio
107	Hauptfeldwebel, Feldjäger - 1945	121	German radio team - man carrying radio	304	German crew 12,8 Flak 40 - foot on frame
108	SS Feldgendarmerie - 1945	122	German radio team - man carrying battery	305	German crew 12,8 Flak 40 - holding ammunition
110	SS Pz.Div. Totenkopf	123	Obersturmführer WITTMANN	306	German crew 12,8 Flak 40 - holding ammunition
111	German dispatch - seated	124	Wittmann's gunner	307	German crew 12,8 Flak 40 - gun layer with helmet
113	SS Pz.Div. Russia	125	German officer in parade dress	308	German crew 12,8 Flak 40 - gun layer with field cap
114	Panzergrenadier 1944-1945	126	Todt organisation 1944 - Einsatzgruppenleiter		

BRITISH ARMY

201	Paratrooper - Arnhem 1944
202	Paratrooper - Arnhem 1944 - gunner
203	
204	Motorcycle M.P. 1944
205	Motorcycle dispatch rider 1944
206	Paratrooper - officer

VIET-NAM

155	USMC tank crew in Viet-Nam
156	USMC tank crew in Viet-Nam
157	USMC mortar team - soldier
158	USMC wearing jungle hat
159	USMC radio operator - Viet-Nam
180	Viet-Nam - killed man
181	Viet-Nam - gunner
182	Viet-Nam - 173rd without helmet
183	Viet-Nam - 173rd with helmet
184	Two dead soldiers (resin)
185	Gunner walking step by step
186	Private with machete in hand
187	Negro with M60 in fire blind position
188	Negro with M60 on hip
189	Private standing in ambush
190	Private in ambush, lying down position
191	Private lying down
192	ARVN Ranger - Saigon Tet '68
193	Nva Regular South Viet-Nam '68
194	U.S. Rangers
195	Young Viet-Cong
196	Woman Viet-Cong in pyjama
197	U.S. soldier carrying grenade vest

CIVILIANS

501	Civilian male worker
502	Civilian female country type
503	Village priest
504	Nun in cornet
505	Civilian in waistcoat
506	Civilian in dungarees with shove
507	Civilian woman in WWII period
508	Elderly civilian man with walking stick
509	Young woman in WWII style dress
510	Gestapo agent in civilian clothes
511	Pregnant woman holding child
512	Civilian in overcoat raising his hat
513	School children (two pieces)
514	Civilian man with straw hat
515	Contestant singer
516	Scarecrow with top hat
517	Scarecrow with bird

FRANCE (54 mm)

52	Régiment horion Liégeois - 1760
55	Mousquetaire de la maison du Roy 1ère compagnie, service à pied - 1715

U.S. ARMY

151	U.S. tank crew in one piece twill suit - 1944
152	U.S. tank crew in field jacket
153	U.S. tank crew in field jacket M41
154	U.S. mechanic
160	U.S. army baseball player - Pitcher
161	U.S. army base ball player - Batter
165	Two U.S. army scouts - Europe 1945
166	G.I. Ardennes 1944
167	Sherman tank crewman
168	Sherman tank crewman
169	U.S. tanker ETO with helmet and goggles
170	U.S. tanker with field glasses
171	U.S. officer reading a map
172	Two half figures: U.S. tank crew 1944
173	U.S. private seating and eating
174	Seated U.S. ambulance man 1944
175	Standing ambulance man
176	U.S. M.P. showing the way
177	Seated negro soldier
178	USMC drill sergeant
179	USMC private in drill position

ETCHED BRASS

87/1	Perforated steel plate (2 pieces)
87/2	Mechanical wrench
87/3	Personnal accessories set
87/4	German and U.S. rifle slings
87/5	German ammunition boxes

POSTERS

S001	Playboy magazine
S002	German posters, newspapers, road signs, etc...
S003	Safety pins
S004	Cobblestone (printed relief)
S007	Wall maps
S011	WWII - German posters
S012	WWII - U.S. posters
S013	WWII - British posters
S014	WWII - Belgian posters
S015	WWII - French and Russian posters
S016	American flags
S017	French flags
S018	British flags
S019	Belgian flags
S020	Israël flags
S021	Air recognition signal
S022	Short - pile carpets
S023	Cobblestone A (printed relief)
S024	Cobblestone B (printed relief)
S025	Brick wall (printed relief)
S026	Brick wall (printed relief)

MIDDLE AGES (54 mm)

60	CAROLUS MAGNUS king of the Franks
61	EGINHARD chronicler monk

RUSSIAN ARMY 40-45

401	Red Army rifle forces, Sergeant
402	Tank crewman, 1st Moscow Mot. Rofle Div.
403	Red Army, anti-tank grenadier
404	Terek Cossacks, Lieutenant, field dress
405	Kuban Cossacks, Captain
406	Senior Sergeant, Red Army tank forces
407	Red Army, medical branch (woman)

ACCESSORIES

	resin or plaster
R.001	Brazier (Charcoal pan) and accessories
R.002	Landau-baby carriage pram (2 pieces)
R.003	Poubelles - dustbin - garbage can (4 pieces)
R.004	Home radio (4 pieces)
R.005	Square War Memorial
R.006	Railway track
R.007	Viet-Cong tunnel
R.008	Jungle ground with a tunnel access
R.009	River bed with two section of tree trunks
R.010	Back garden W.C. with figure included
R.011	Viet-Cong hut
R.012	
R.013	
R.014	U.S. Military police control post
R.015	Vietnamese barrack on piles
R.016	Vietnamese house
R.017	U.S. Air Force / Marines / Army barrack

SCALE 1/48

U.S. ARMY

P001	Ground personal (5 pieces)
P002	1 aircraft pilot, 2 helicopter pilots, 2 deck crew
P003	Deck crew (5 pieces)
P004	Catapult crew (5 pieces)

UNITED STATES (54 mm)

2000	Abraham Lincoln president
2001	" 4th Texas volunteer, Cy H" - 1861
2002	The bucktails Volunteer of the 42nd Pennsylvania Rgt. 1880
2003	Royal Fencible American Rgt. raised in Nova Scotia 1775
2004	Private with full equipment - 1943

BELGIUM (54 mm)

41	Chasseur à cheval, 2nd Rgt. - 1831
50	Lancers, 1st or 2nd Rgt. - 1850
51	Lancers, 1st or 2nd Rgt. - 1850 -Trumpeter
53	Gendarmerie Nationale, Service dress - 1863
54	Grenadier à pied, Service dress - 1880
56	Sailor - 1830
57	Sailor - at the present day
58	Marine - 1832
59	Navy officer in oilcloth - at the present day

HOW TO PREPARE AND PAINT YOUR FIGURINES

Materials required: Very fine sandpaper or steel wool o5 - a smooth file - a cutter or X-acto.

Paint: Flat Humbrol: Khaki HF.1 - Flat 29 - Flat 26 - Flat 33 - Flat 24 - Flat 61 - Drill khaki HM.8 - MC.21 - Sand HI.4 - Oil paint: Burnt sienna - Yellow ochre - Flesh colour - Red - White - Black.

Brushes required: Marten. Flat-tipped: («cat's tongue») n^{os} 2 - 4 - 6. Round-tipped: Rein Kolinsky or Winsor & Newton n^{os} 1 - 0 - 00 - 000.

How to Prepare the Figurine: Wash the figurine with soapy water to remove the protective talc and dry with a cloth. Remove any rough spots with the cutter or smooth file. Go over the figurine with o5 steel wool to give it an even, polished surface. Remove the dust from the filing with a soft brush (water-colour model n^o 12).

Prime colour:

Face and hands: Flat Humbrol 61, flesh-coloured for a light tone - Flat Humbrol HI.4 sand-coloured for a dark tone.

Uniforms: American and German - Khaki Humbrol HF.1 - Let dry for twenty-four hours.

How to Paint the Face and Hands: Cover all surfaces to be panted with dark burnt sienna. Remove the surplus paint with another brush (soft and dry). Clean the brush with a dry cloth and repeat the process until a uniform tone is obtained, making sure that the prime colour is well-defined. With a flat-tipped n^o 2 brush, lighten the forehead, the bridge of the nose, the nostrils, the chin, the lower jaw, and the throat with a mixture of ochre (3/4) and flesh colour (1/4), remembering to clean the brush carefully with a cloth before beginning. Work carefully. Repeat the process if the contrast is not apparent enough.

Cheek bones: A dot of red pain. A well-blended mixture of ochre and red will yield a less pinkish tone.

Do the eyes: To make them appear more deep-set, darken the space between the upper eyelid and the eyebrow with the burnt sienna, working outwards from the nose.

For a beard of several days: (after the face has been left to dry for 2-3 days). Mix the dark blue and the burnt sienna. Clean the brush and dab the area concerned.

Uniform: Dry-brush with Humbrol paint. Do not mix your colours. Take the prime colour with a screwdriver and add a few drops of liquid. Mix MC.21 and flat 29 in equal parts. Clean the brush, and dry-brush the uniform. To lighten the xxx the folds, add a little flat yellow no. 24 to the above mixture. If you work carefully, the differences in the tones will be well-defined when the paint dries.

Paint the webb and the belt in drill Khaki HM.8. Before finishing, highlight all the details (the outline of the pockets, the gear, etc.) with a highly-diluted flat glaze. Finish up with a mixture of drill khaki and white, dry-brushing the most noticeable areas very lightly.

German Uniform: The procedure is the same as above, but the colours used are as follows: 1. Field grey HM.6 - 2. Field grey HM.6 and white. The gear and boots are in glazed black leather.

Arms: Wooden Parts: burnt sienna on an HI.4 sand background. Metallic Parts: dry-brush with a mixture of black oil paint and a small amount of silver dust.

One last piece of advice: Do not attempt to achieve the desired tone in one coat. A step-by-step approach will produce better results. When you change tones, do not re-use the brush you have just finished with.

Use a dry clean one instead.

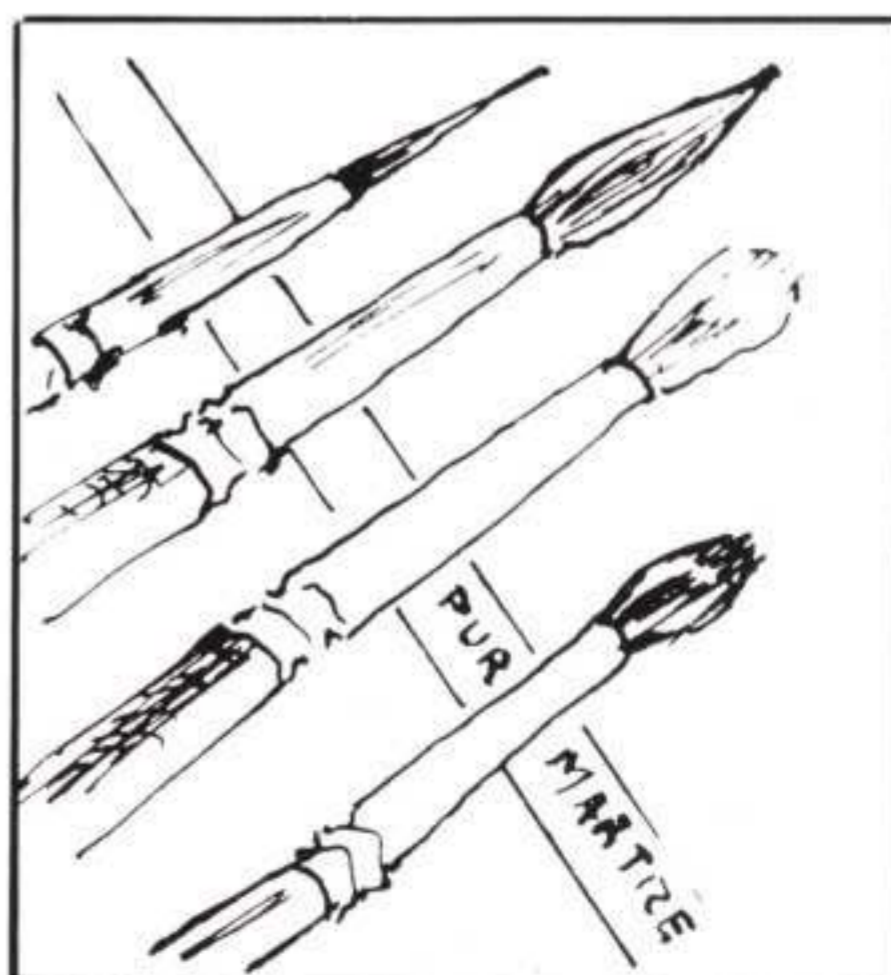
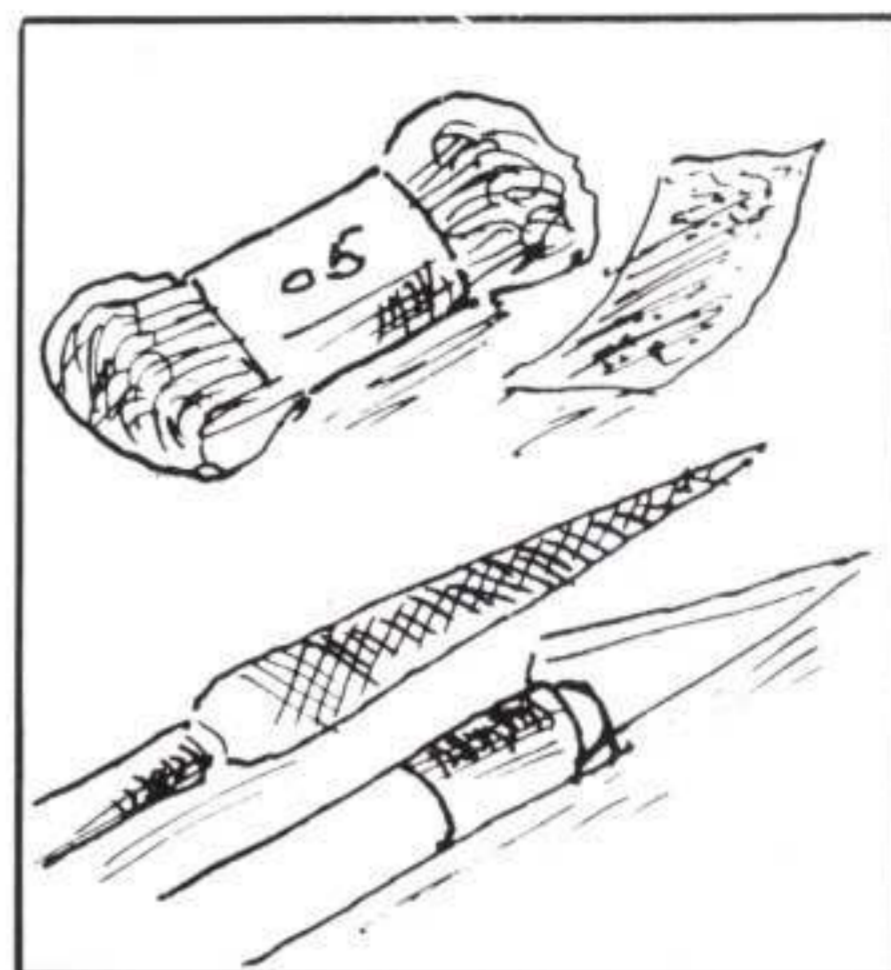

DISTRIBUTEURS INTERNATIONAUX INTERNATIONAL DISTRIBUTORS

ITALY

ASTROMODEL Snc.
Via M. Lercari Sez.M.n.5
Darsena
16126 GENOVA

PORTUGAL

Brintec
410 rua Elias Garcia
2700 AMADORA - Lisboa

UNITED KINGDOM

HISTOREX AGENTS
3, Castle street
Dover CT 16 1QJ.

U.S.A.

WARWINDS LEGACY Distr.

West Port Industrial Park
804 Fee Fee Road
Maryland heights - Mo.63043

WEST GERMANY

J. Peddinghaus
20, Beethovenstrasse
5870 HEMER

GREECE

"Collector's items"
19, Mitropoleos street
54624 Thessaloniki

HOLLAND

Ten Brink & Verlinden
Markerkant 1201.09
1314 AK ALMERE

De nouveaux points de distributions seront les bienvenus pour: Autriche - Australie - Espagne

Autres productions réalisées en notre atelier (non inclu dans le catalogue):

Etched brass n° 87/1 PSP

n° 87/2 clef mécanique.

Plastique injecté:

Kit de conversion 251/17 sur base de chassis commercialisé.

We hope, for the future, to be able to distribute our products in: Austria - Australia - Spain

Other materials produced in our workshops (not mentioned in the catalogue):

Etched brass n° 87/1 PSP

n° 87/2 mechanical wrench.

Creosated plastic:

Conversion kit 251/17, starting from a frame available commercially.

BELGO-MODELS

6, rue Genot

4032 CHENEE

BELGIQUE

 003241/672210